

BWPM Series



Due to accurate wire winding technology, these chip inductors are designed for filtering, impedance matching, resonance and choke circuits for RF designer. Both standard series custom designs are available.

Features

- RoHS Compliant and Halogen Free
- Ceramic body and wire wound construction provide high Q and SRFs
- Higher Q and lower DCR than other inductors
- Exceptional current handling capability
- PM series is for high power and high frequency application

Applications

- Wireless embedded portable devices
- GPS receiver
- Base Station
- Repeater
- Set Top Box
- Cable / IP Modem
- Security system and other RF modules

Product Identification

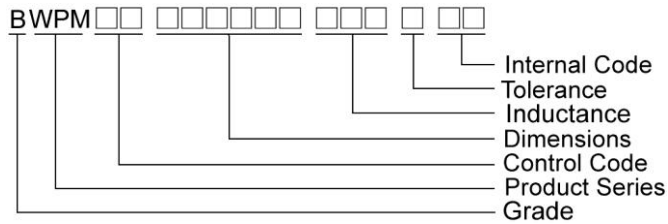

Shape and Dimensions / Recommended Pattern

BWPM00161108

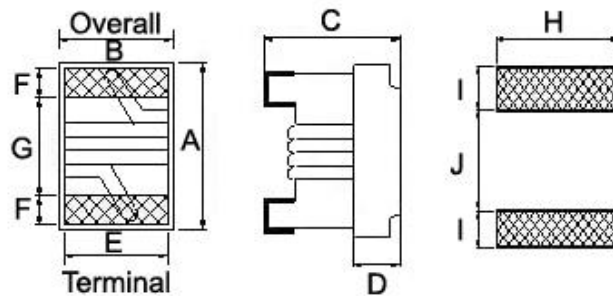

Dimensions

	A	B	C	D	E	F	G	H	I	J
BWPM00161108	1.6 ^{+0.2} _{-0.1}	1.12 ± 0.1	0.82 ^{+0.2} _{-0.1}	0.30	0.95	0.30	0.70	1.02	0.64	0.64

SMD Wire Wound Ceramic Chip Inductors - BWPM Series

Electrical Characteristics

Part Number	Inductance (nH)	Tolerance (±%)	Test Frequency (MHz)	Q Min	Test Frequency (MHz)	SRF (GHz) Min	RDC (Ω) Max	Irms (mA) Max	Color
BWPM001611082N2□00	2.2	±0.5nH	100	25	250	18	0.018	1400	Black
BWPM001611083N9□00	3.9	±0.2nH/±0.5nH	100	38	250	11	0.032	1000	Brown
BWPM001611085N6□00	5.6	±0.5nH	100	38	250	10	0.045	900	Red
BWPM001611086N8□00	6.8	±0.2nH/±0.5nH	100	38	250	7	0.045	900	Orange
BWPM001611088N2□00	8.2	±0.5nH	100	38	250	7	0.058	800	Yellow
BWPM0016110810N□00	10	5 / 2	100	38	250	5	0.058	800	Green
BWPM0016110812N□00	12	5 / 2	100	38	250	5	0.071	750	Blue
BWPM0016110815N□00	15	5	100	42	250	4.5	0.085	700	Violet
BWPM0016110818N□00	18	5 / 2	100	42	250	3.5	0.085	700	Brown
BWPM0016110822N□00	22	5 / 2	100	42	250	3.3	0.099	640	White
BWPM0016110827N□00	27	5 / 2	100	42	250	2.8	0.116	590	Black
BWPM0016110833N□00	33	5	100	42	250	2.5	0.132	550	Brown

Note: When ordering, please specify tolerance code. Tolerance : C=±0.2nH , D=±0.5nH , G=±2% , J=±5%

- Operating temperature range - 40°C ~ 125°C(Including self - temperature rise)
- Irms for a 15°C temperature rise from 25°C ambient with current
- Measure Equipment :
 L & Q : Agilent E4991A+Agilent HP16197A
 SRF : Agilent HP8753D
 RDC : Chroma 16502
 Irms : HP4284A+HP42841A/HP4285A+HP42841A

Typical **L** vs. **F** Frequency

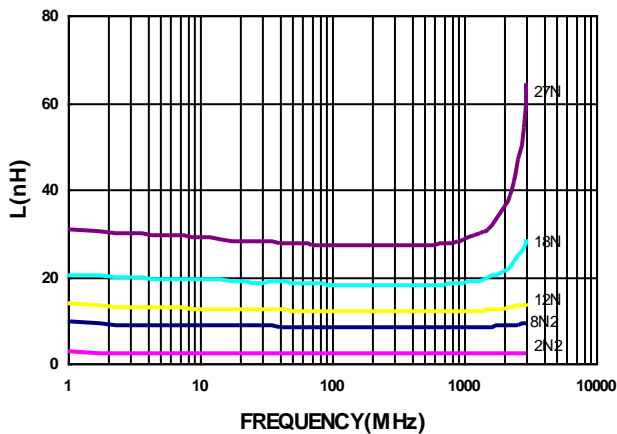

Typical **Q** vs. **F** Frequency

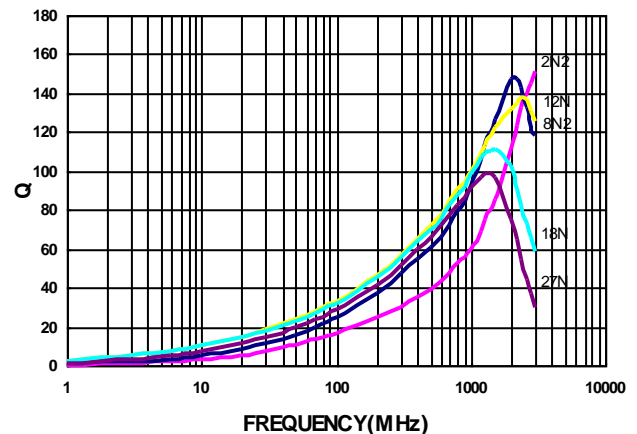

SMD Wire Wound Ceramic Chip Inductors - BWPM Series

Packaging Specifications

Tape Dimensions

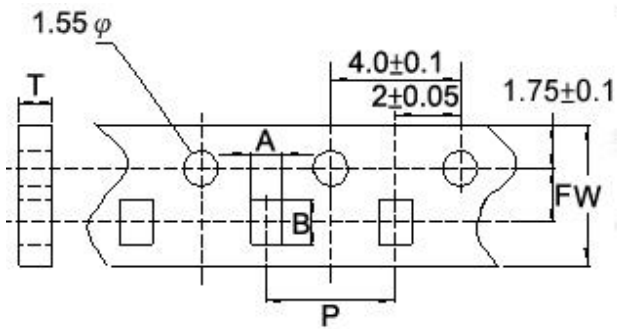

Tape Material

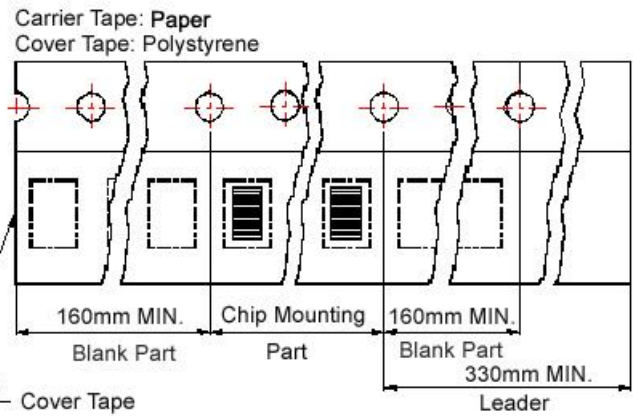

Reel Dimensions

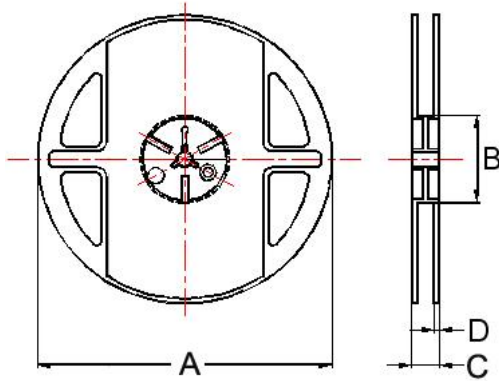

Dimensions in mm

TYPE	Tape Dimensions						Reel Dimensions				Quantity PCS / Reel
	A	B	T	W	P	F	A	B	C	D	
BWPM00161108	1.25	1.90	1.05	8	4	3.5	178	60	12	1.5	4000