

BWVS Series

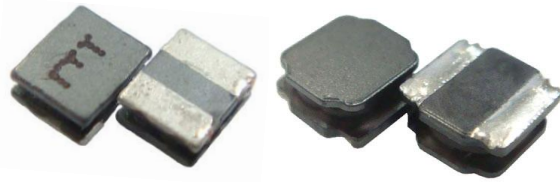

BWVS series, an automatic assembly constructed power inductor, is shielded with magnetic resin and suitable for the portable DC-DC converter applications.

Features

- RoHS, Halogen Free and REACH Compliance
- Shielded with magnetic resin
- Various package size and wide inductance range
- Optimize electrical characteristics by using different ferrite core figures

Applications

- AP Routers
- STBs
- LCD TVs, monitors and panels
- Game consoles
- DC/DC converters

Product Identification

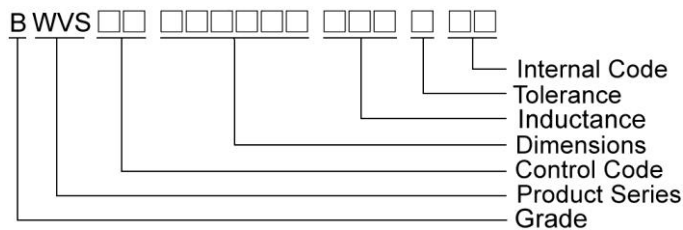

Shape and Dimensions

Figure 1

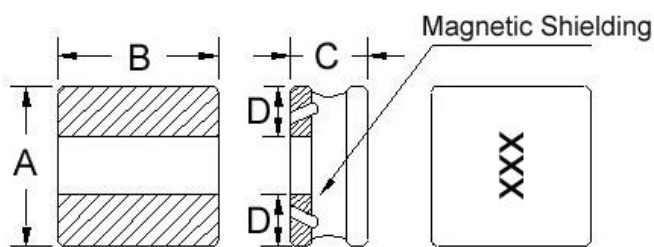

Recommended Pattern

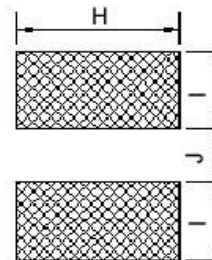

Dimensions in mm

TYPE	FIG	A	B	C	D	H	I	J
BWVS00404012	1	4.0±0.2	4.0±0.2	1.20±0.1	1.5	4.2	1.5	1.2

Sealed Power Inductors - BWVS Series

Shape and Dimensions

Recommended Pattern

Figure 2

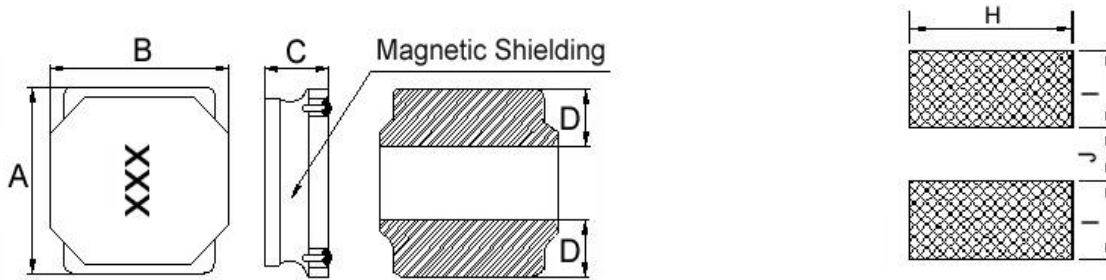

Dimensions in mm

TYPE	FIG	A	B	C	D	H	I	J
BWVS00404018	2	4.0±0.2	4.0±0.2	1.8 ^{+0.2} _{-0.30}	1.3±0.3	3.7	1.2	1.6
BWVS00404026	2	4.0±0.2	4.0±0.2	2.6±0.2	1.4	3.7	1.2	1.6

Shape and Dimensions

Recommended Pattern

Figure 3

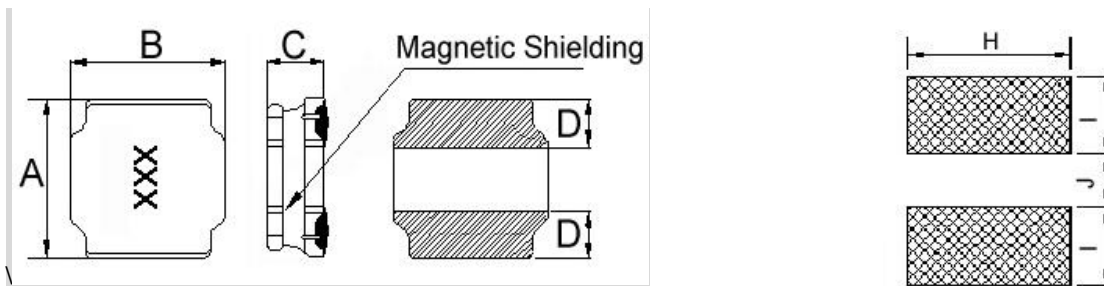

Dimensions in mm

TYPE	FIG	A	B	C	D	H	I	J
BWVS00505020	3	5.0±0.2	5.0±0.2	2.0 ^{+0.2} _{-0.30}	1.8±0.3	4.0	1.5	2.1
BWVS00505040	3	5.0±0.2	5.0±0.2	4.0 ^{+0.2} _{-0.30}	1.6±0.3	4.0	1.5	2.1
BWVS00606020	3	6.0±0.2	6.0±0.2	2.0 ^{+0.2} _{-0.30}	1.7±0.3	5.7	1.6	2.9
BWVS00606028	3	6.0±0.2	6.0±0.2	2.8 ^{+0.2} _{-0.30}	1.9±0.3	5.7	1.6	2.9
BWVS00606045	3	6.0±0.2	6.0±0.2	4.5 ^{+0.2} _{-0.30}	1.8±0.3	5.7	2.0	2.4
BWVS00808040	3	8.0±0.2	8.0±0.2	4.0 ^{+0.2} _{-0.30}	2.3±0.3	7.5	2.5	3.4

Electrical Characteristics

Part Number	Inductance (uH)	Tolerance (±%)	Test Frequency (kHz)	RDC (mΩ) ±30%	Isat (A) Typ. (Max)	Irms (A) Typ. (Max)	Marking
BWVS004040121R0□00	1.0	20, 30	100	48	2.50(2.25)	1.70(1.53)	1R0
BWVS004040121R5□00	1.5	20, 30	100	58	2.10(1.89)	1.60(1.44)	1R5
BWVS004040122R2□00	2.2	20, 30	100	65	1.70(1.53)	1.50(1.35)	2R2
BWVS004040123R3□00	3.3	20, 30	100	90	1.30(1.17)	1.40(1.26)	3R3
BWVS004040124R7□00	4.7	20, 30	100	110	1.10(0.99)	1.20(1.08)	4R7
BWVS004040126R8□00	6.8	20, 30	100	135	0.90(0.81)	1.05(0.94)	6R8
BWVS00404012100□00	10	20, 30	100	190	0.78(0.70)	0.90(0.81)	100
BWVS00404012150□00	15	20, 30	100	250	0.65(0.58)	0.85(0.76)	150
BWVS00404012220□00	22	20, 30	100	400	0.52(0.46)	0.75(0.67)	220
BWVS00404012330□00	33	20, 30	100	600	0.44(0.39)	0.70(0.63)	330
BWVS00404012470□00	47	20, 30	100	930	0.35(0.31)	0.50(0.45)	470

Note: When ordering, please specify tolerance code. Tolerance: M=±20% , T =±30%

- Operating temperature range - 55°C ~ 125°C(Including self - temperature rise)
- Isat for Inductance drop 30% from its value without current
- Irms for a 40°C temperature rise from 25°C ambient with current
- Measure Equipment :
 L : Agilent HP4284A+Agilent HP42841A, 100kHz 1V
 RDC : DIGITAL MILLINHM METER CHROMA 16502, or equivalent
 Isat & Irms : Agilent HP4284A

Test Instruments : HP4284A Material/Impedance Analyzer

Inductance vs. DC Current

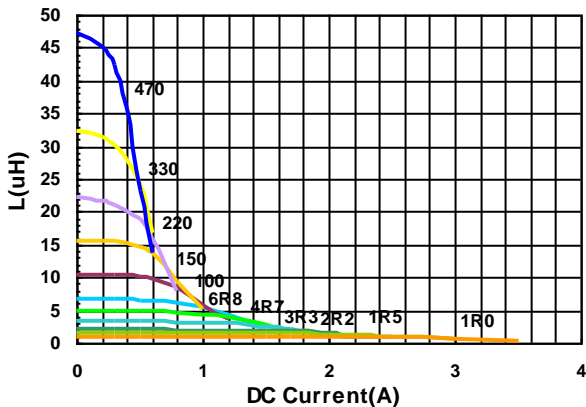

Temperature Change vs. DC Current

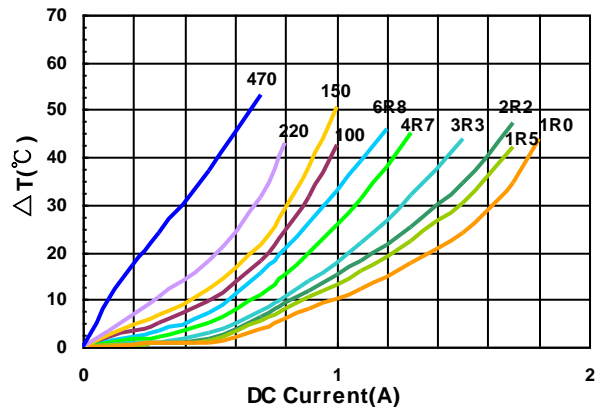

Electrical Characteristics

Part Number	Inductance (uH)	Tolerance (±%)	Test Frequency (kHz)	RDC (mΩ) ±20%	Isat (A) Typ. (Max)	Irms (A) Typ. (Max)	Marking
BWVS004040181R0□00	1.0	20, 30	100	32	4.10(3.69)	2.80(2.52)	1R0
BWVS004040181R5□00	1.5	20, 30	100	40	3.30(2.97)	2.60(2.34)	1R5
BWVS004040181R8□00	1.8	20, 30	100	55	2.80(2.50)	2.50(2.20)	1R8
BWVS004040182R2□00	2.2	20, 30	100	60	2.80(2.52)	2.50(2.25)	2R2
BWVS004040183R3□00	3.3	20, 30	100	70	2.20(1.98)	2.10(1.89)	3R3
BWVS004040183R6□00	3.6	20, 30	100	75	2.10(1.89)	1.90(1.71)	3R6
BWVS004040183R9□00	3.9	20, 30	100	75	2.10(1.89)	1.90(1.71)	3R9
BWVS004040184R7□00	4.7	20, 30	100	90	2.00(1.80)	1.70(1.53)	4R7
BWVS004040186R8□00	6.8	20, 30	100	110	1.60(1.44)	1.50(1.35)	6R8
BWVS004040188R2□00	8.2	20, 30	100	155	1.50(1.30)	1.30(1.10)	8R2
BWVS00404018100□00	10	20, 30	100	170	1.40(1.26)	1.20(1.08)	100
BWVS00404018150□00	15	20, 30	100	250	1.00(0.90)	1.00(0.90)	150
BWVS00404018220□00	22	20, 30	100	350	0.90(0.81)	0.85(0.76)	220
BWVS00404018330□00	33	20, 30	100	530	0.80(0.72)	0.70(0.63)	330
BWVS00404018470□00	47	20, 30	100	720	0.70(0.63)	0.56(0.50)	470
BWVS00404018680□00	68	20, 30	100	1000	0.56(0.50)	0.45(0.40)	680
BWVS00404018101□00	100	20, 30	100	1500	0.46(0.41)	0.38(0.34)	101
BWVS00404018121□00	120	20, 30	100	1600	0.38(0.34)	0.36(0.32)	121
BWVS00404018151□00	150	20, 30	100	2500	0.35(0.31)	0.30(0.27)	151
BWVS00404018221□00	220	20, 30	100	4000	0.28(0.25)	0.23(0.20)	221

Note: When ordering, please specify tolerance code. Tolerance: M=±20% , T =±30%

- Operating temperature range - 55°C ~ 125°C(Including self - temperature rise)
- Isat for Inductance drop 30% from its value without current
- Irms for a 40°C temperature rise from 25°C ambient with current
- Measure Equipment :
 L : Agilent HP4284A+Agilent HP42841A, 100kHz 1V
 RDC : DIGITAL MILLINHM METER CHROMA 16502, or equivalent
 Isat & Irms : Agilent HP4284A

Test Instruments : HP4284A Material/Impedance Analyzer

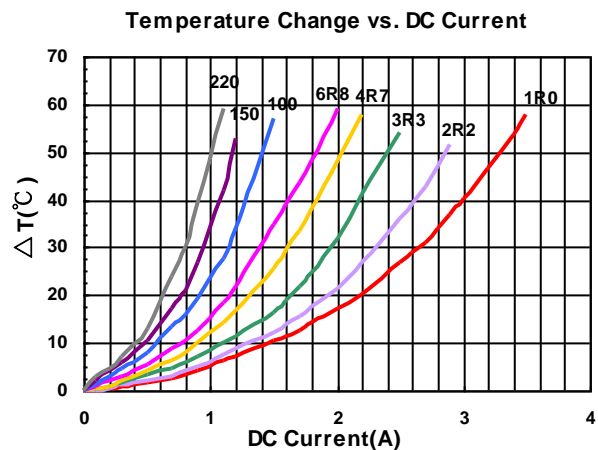
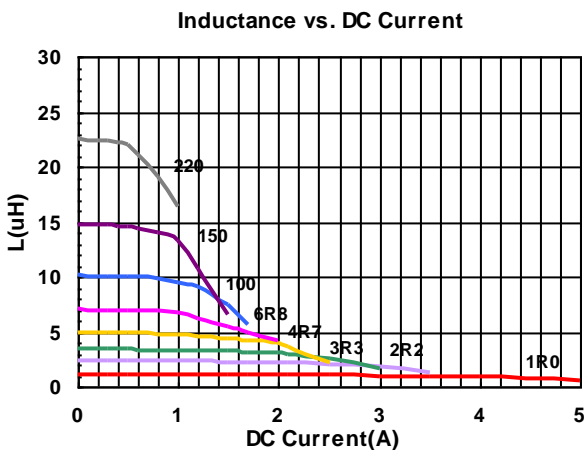

Sealed Power Inductors – BWVS Series

Electrical Characteristics

Part Number	Inductance (uH)	Tolerance (±%)	Test Frequency (kHz)	RDC (mΩ) ±30%	Isat (A) Typ. (Max)	Irms (A) Typ. (Max)	Marking
BWVS004040261R2□00	1.2	20, 30	100	30	3.50(3.15)	3.30(2.97)	1R2
BWVS004040263R3□00	3.3	20, 30	100	45	2.50(2.25)	2.50(2.25)	3R3
BWVS004040264R7□00	4.7	20, 30	100	60	1.80(1.62)	1.80(1.62)	4R7
BWVS00404026220□00	22	20, 30	100	230	0.86(0.77)	1.00(0.90)	220

Note: When ordering, please specify tolerance code. Tolerance: M=±20% , T =±30%

- Operating temperature range - 55°C ~ 125°C(Including self - temperature rise)
- Isat for Inductance drop 30% from its value without current
- Irms for a 40°C temperature rise from 25°C ambient with current
- Measure Equipment :
 L : Agilent HP4284A+Agilent HP42841A, 100kHz 1V
 RDC : DIGITAL MILLINHM METER CHROMA 16502, or equivalent
 Isat & Irms : Agilent HP4284A

Test Instruments : HP4284A Material/Impedance Analyzer

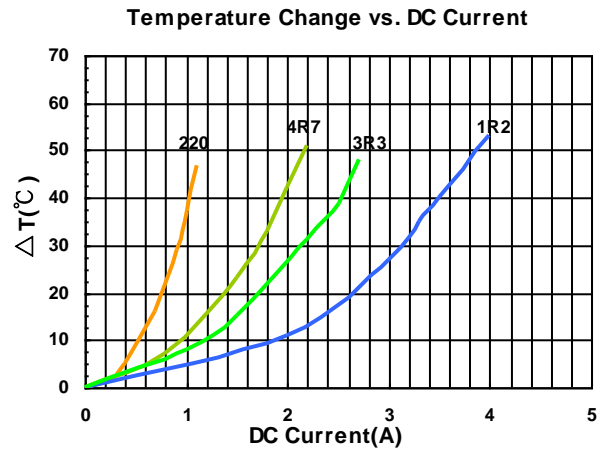
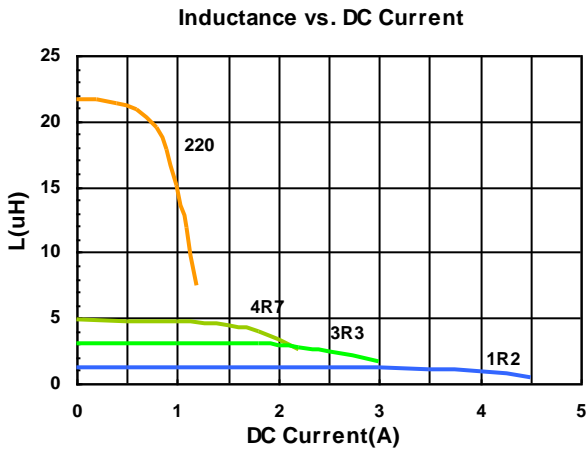

Electrical Characteristics

Part Number	Inductance (uH)	Tolerance (±%)	Test Frequency (kHz)	RDC (mΩ) ±20%	Isat (A) Typ. (Max)	Irms (A) Typ. (Max)	Marking
BWVS005050201R0□00	1.0	20, 30	100	21	5.1(4.59)	4.0(3.60)	1R0
BWVS005050201R2□00	1.2	30	100	21	4.8(4.32)	3.8(3.42)	1R2
BWVS005050201R5□00	1.5	20, 30	100	26	4.2(3.78)	3.5(3.15)	1R5
BWVS005050202R2□00	2.2	20, 30	100	35	3.4(3.06)	3.2(2.88)	2R2
BWVS005050202R7□00	2.7	20, 30	100	38	3.05(2.7)	2.9(2.60)	2R7
BWVS005050203R3□00	3.3	20, 30	100	48	3.0(2.70)	2.8(2.52)	3R3
BWVS005050204R7□00	4.7	20, 30	100	60	2.2(1.98)	2.2(1.98)	4R7
BWVS005050205R6□00	5.6	20, 30	100	82	2.05(1.84)	2.0(1.80)	5R6
BWVS005050206R8□00	6.8	20, 30	100	90	2.0(1.80)	1.8(1.62)	6R8
BWVS00505020100□00	10	20, 30	100	120	1.6(1.44)	1.6(1.44)	100
BWVS00505020150□00	15	20, 30	100	190	1.3(1.17)	1.2(1.08)	150
BWVS00505020220□00	22	20, 30	100	260	1.0(0.90)	1.0(0.90)	220
BWVS00505020330□00	33	20, 30	100	460	0.8(0.72)	0.75(0.67)	330
BWVS00505020470□00	47	20, 30	100	580	0.65(0.58)	0.65(0.58)	470

Note: When ordering, please specify tolerance code. Tolerance: M=±20% , T =±30%

- Operating temperature range - 55°C ~ 125°C(Including self - temperature rise)
- Isat for Inductance drop 30% from its value without current
- Irms for a 40°C temperature rise from 25°C ambient with current
- Measure Equipment :
 L : Agilent HP4284A+Agilent HP42841A, 100kHz 1V
 RDC : DIGITAL MILLINHM METER CHROMA 16502, or equivalent
 Isat & Irms : Agilent HP4284A

Test Instruments : HP4284A Material/Impedance Analyzer

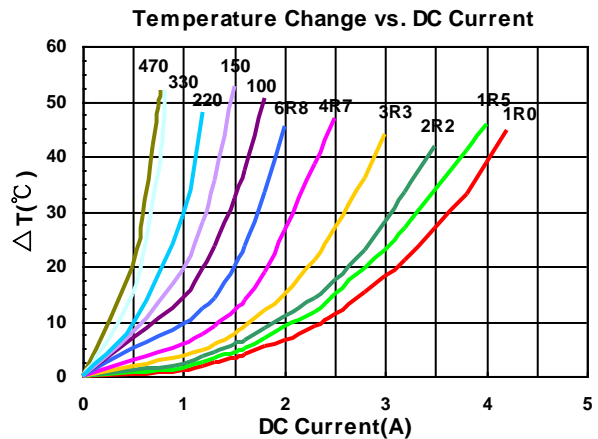
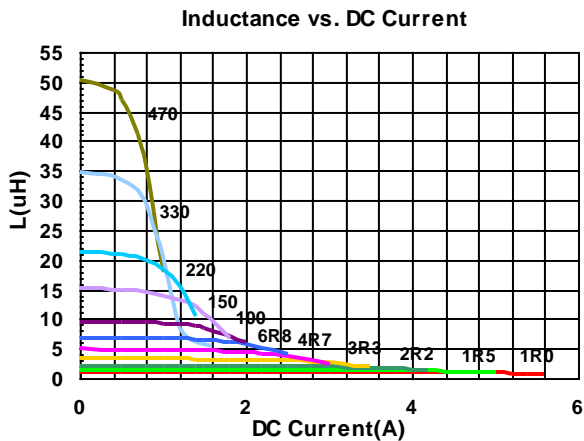

Electrical Characteristics

Part Number	Inductance (uH)	Tolerance (±%)	Test Frequency (kHz)	RDC (mΩ) ±30%	Isat (A) Typ. (Max)	Irms (A) Typ. (Max)	Marking
BWVS005050401R0□00	1.0	20, 30	100	14	7.5(6.75)	4.6(4.14)	1R0
BWVS005050401R2□00	1.2	20, 30	100	15	7.4(6.66)	4.5(4.05)	1R2
BWVS005050401R5□00	1.5	20, 30	100	16	7.1(6.39)	4.4(3.96)	1R5
BWVS005050402R2□00	2.2	20, 30	100	21	5.7(5.13)	3.7(3.33)	2R2
BWVS005050403R0□00	2.2	20, 30	100	26	4.8(4.32)	3.5(3.15)	3R0
BWVS005050403R3□00	3.3	20, 30	100	26	4.8(4.32)	3.5(3.15)	3R3
BWVS005050403R6□00	3.6	20, 30	100	31	4.2(3.70)	3.3(2.90)	3R6
BWVS005050404R7□00	4.7	20, 30	100	32	4.2(3.78)	3.2(2.88)	4R7
BWVS005050406R8□00	6.8	20, 30	100	50	3.3(2.97)	2.4(2.16)	6R8
BWVS00505040100□00	10	20, 30	100	60	2.8(2.52)	2.2(1.98)	100
BWVS00505040150□00	15	20, 30	100	90	2.3(2.07)	1.8(1.62)	150
BWVS00505040220□00	22	20, 30	100	135	1.8(1.62)	1.4(1.26)	220
BWVS00505040270□00	27	20, 30	100	180	1.6(1.44)	1.2(1.08)	270
BWVS00505040330□00	33	20, 30	100	190	1.5(1.35)	1.1(0.99)	330
BWVS00505040470□00	47	20, 30	100	310	1.2(1.08)	0.9(0.81)	470
BWVS00505040680□00	68	20, 30	100	540	1.0(0.90)	0.78(0.7)	680
BWVS00505040101□00	100	20, 30	100	800	0.7(0.60)	0.6(0.50)	101

Note: When ordering, please specify tolerance code. Tolerance: M=±20% , T =±30%

- Operating temperature range - 55°C ~ 125°C(Including self - temperature rise)
- Isat for Inductance drop 30% from its value without current
- Irms for a 40°C temperature rise from 25°C ambient with current
- Measure Equipment :
 L : Agilent HP4284A+Agilent HP42841A, 100kHz 1V
 RDC : DIGITAL MILLINHM METER CHROMA 16502, or equivalent
 Isat & Irms : Agilent HP4284A

Test Instruments : HP4284A Material/Impedance Analyzer

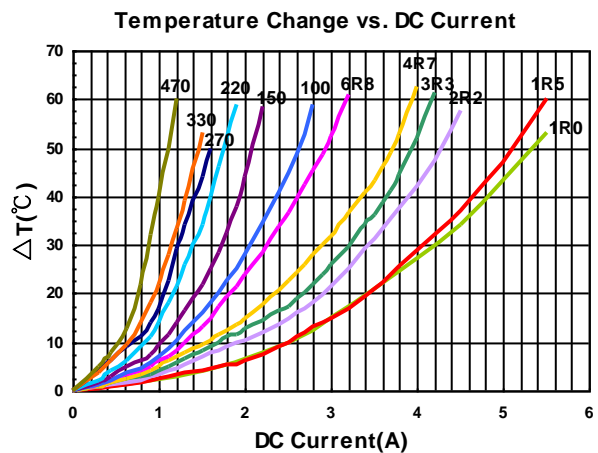
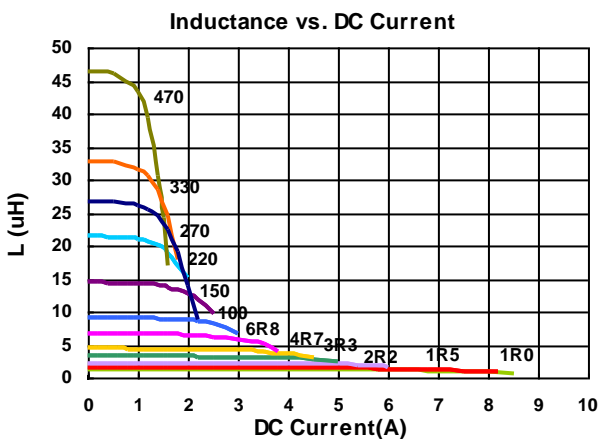

Sealed Power Inductors - BWVS Series

Electrical Characteristics

Part Number	Inductance (uH)	Tolerance (±%)	Test Frequency (kHz)	RDC (mΩ) ±30%	Isat (A) Typ. (Max)	Irms (A) Typ. (Max)	Marking
BWVS00606020R50□00	0.5	30	100	13	8.0(7.20)	5.3(4.77)	R50
BWVS00606020R90□00	0.9	30	100	18	6.3(5.67)	4.2(3.78)	R90
BWVS006060201R0□00	1.0	30	100	19	6.2(5.58)	4.1(3.69)	1R0
BWVS006060201R5□00	1.5	20, 30	100	26	5.0(4.50)	3.6(3.24)	1R5
BWVS006060202R2□00	2.2	20, 30	100	34	4.2(3.78)	3.2(2.88)	2R2
BWVS006060203R3□00	3.3	20, 30	100	40	3.2(2.88)	2.7(2.43)	3R3
BWVS006060204R7□00	4.7	20, 30	100	58	2.5(2.25)	2.2(1.98)	4R7
BWVS006060206R8□00	6.8	20, 30	100	85	2.2(1.98)	1.8(1.62)	6R8
BWVS00606020100□00	10	20, 30	100	125	2.0(1.80)	1.6(1.44)	100
BWVS00606020150□00	15	20, 30	100	190	1.3(1.17)	1.3(1.17)	150
BWVS00606020220□00	22	20, 30	100	260	1.1(0.99)	1.1(0.99)	220

Note: When ordering, please specify tolerance code. Tolerance: M=±20% , T =±30%

- Operating temperature range - 55°C ~ 125°C(Including self - temperature rise)
- Isat for Inductance drop 30% from its value without current
- Irms for a 40°C temperature rise from 25°C ambient with current
- Measure Equipment :
 L : Agilent HP4284A+Agilent HP42841A, 100kHz 1V
 RDC : DIGITAL MILLINHM METER CHROMA 16502, or equivalent
 Isat & Irms : Agilent HP4284A

Test Instruments : HP4284A Material/Impedance Analyzer

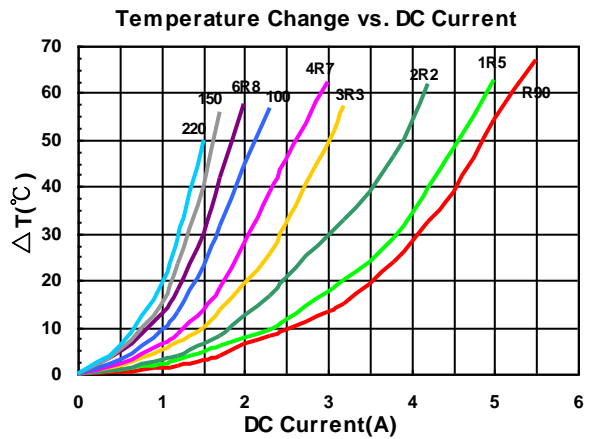
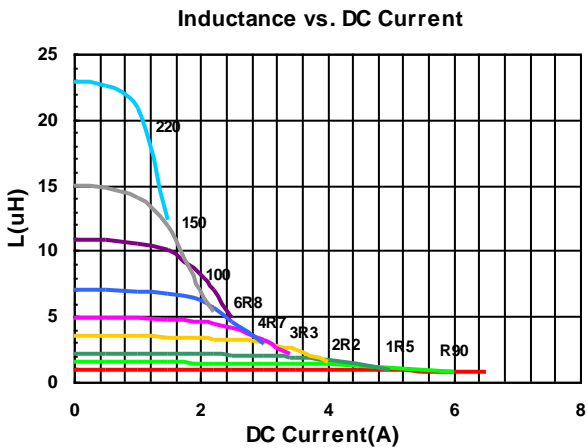

Electrical Characteristics

Part Number	Inductance (uH)	Tolerance (±%)	Test Frequency (kHz)	RDC (mΩ) ±30%	Isat (A) Typ. (Max)	Irms (A) Typ. (Max)	Marking
BWVS006060281R0□00	1.0	20, 30	100	13	7.6(6.84)	5.2(4.68)	1R0
BWVS006060281R5□00	1.5	20, 30	100	16	6.3(5.67)	4.8(4.32)	1R5
BWVS006060282R2□00	2.2	20, 30	100	20	5.4(4.86)	4.0(3.60)	2R2
BWVS006060282R7□00	2.7	20, 30	100	26	4.9(4.41)	3.7(3.33)	2R7
BWVS006060283R3□00	3.3	20, 30	100	28	4.3(3.87)	3.5(3.15)	3R3
BWVS006060284R7□00	4.7	20, 30	100	38	3.7(3.33)	3.2(2.88)	4R7
BWVS006060286R0□00	6.0	20, 30	100	45	3.3(2.97)	2.8(2.52)	6R0
BWVS006060286R8□00	6.8	20, 30	100	50	3.1(2.79)	2.7(2.43)	6R8
BWVS00606028100□00	10	20, 30	100	65	2.5(2.25)	2.3(2.07)	100
BWVS00606028150□00	15	20, 30	100	95	2.0(1.80)	1.8(1.62)	150
BWVS00606028220□00	22	20, 30	100	135	1.6(1.44)	1.5(1.35)	220
BWVS00606028330□00	33	20, 30	100	220	1.3(1.17)	1.4(1.26)	330
BWVS00606028470□00	47	20, 30	100	320	1.1(0.99)	1.0(0.90)	470
BWVS00606028680□00	68	20, 30	100	420	0.98(0.88)	0.9(0.81)	680
BWVS00606028101□00	100	20, 30	100	600	0.82(0.73)	0.8(0.72)	101

Note: When ordering, please specify tolerance code. Tolerance: M=±20% , T =±30%

- Operating temperature range - 55°C ~ 125°C(Including self - temperature rise)
- Isat for Inductance drop 30% from its value without current
- I rms for a 40°C temperature rise from 25°C ambient with current
- Measure Equipment :
 L : Agilent HP4284A+Agilent HP42841A, 100kHz 1V
 RDC : DIGITAL MILLINHM METER CHROMA 16502, or equivalent
 Isat & I rms : Agilent HP4284A

Test Instruments : HP4284A Material/Impedance Analyzer

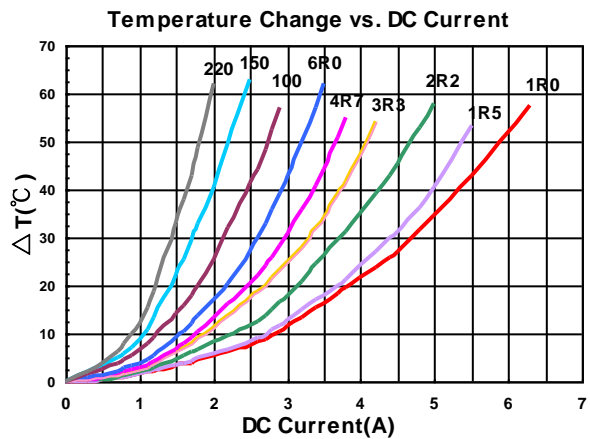
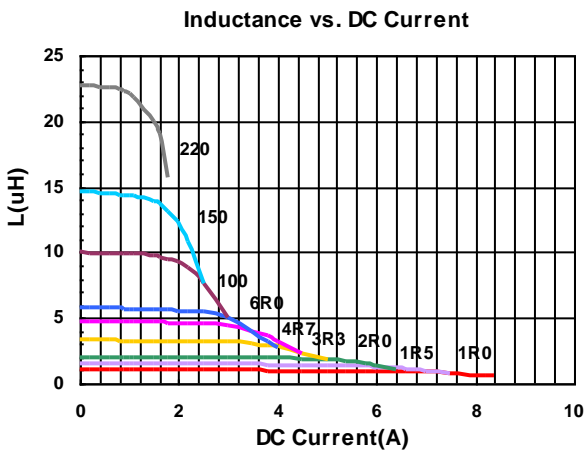

Electrical Characteristics

Part Number	Inductance (uH)	Tolerance (±%)	Test Frequency (kHz)	RDC (mΩ) ±30%	Isat (A) Typ. (Max)	Irms (A) Typ. (Max)	Marking
BWVS006060451R0□00	1.0	20, 30	100	12	12.2(10.98)	6.5(5.85)	1R0
BWVS006060451R2□00	1.2	20, 30	100	13	10.6(9.50)	5.9(5.30)	1R2
BWVS006060451R5□00	1.5	20, 30	100	15	10.4(9.36)	5.9(5.31)	1R5
BWVS006060451R8□00	1.8	20, 30	100	17	9.6(8.64)	5.6(5.04)	1R8
BWVS006060452R2□00	2.2	20, 30	100	18.4	8.8(7.92)	5.1(4.59)	2R2
BWVS006060452R3□00	2.3	20, 30	100	19	8.8(7.92)	5.0(4.50)	2R3
BWVS006060453R0□00	3.0	20, 30	100	22	7.8(7.02)	4.4(3.96)	3R0
BWVS006060453R3□00	3.3	20, 30	100	24	7.5(6.75)	4.3(3.87)	3R3
BWVS006060453R6□00	3.6	20, 30	100	24	7.5(6.75)	4.3(3.87)	3R6
BWVS006060453R9□00	3.9	20, 30	100	26	7.0(6.30)	4.0(3.60)	3R9
BWVS006060454R5□00	4.5	20, 30	100	31	6.7(6.03)	3.9(3.51)	4R5
BWVS006060454R7□00	4.7	20, 30	100	31	6.7(6.03)	3.9(3.51)	4R7
BWVS006060455R1□00	5.1	20, 30	100	33	6.0(5.40)	3.5(3.15)	5R1
BWVS006060455R6□00	5.6	20, 30	100	40	5.5(4.95)	3.3(2.97)	5R6
BWVS006060456R3□00	6.3	20, 30	100	40	5.5(4.95)	3.3(2.97)	6R3
BWVS006060456R8□00	6.8	20, 30	100	43	5.3(4.77)	3.2(2.88)	6R8
BWVS006060458R2□00	8.2	20, 30	100	53	4.6(4.10)	2.9(2.60)	8R2
BWVS00606045100□00	10	20, 30	100	57	4.5(4.05)	2.7(2.43)	100
BWVS00606045150□00	15	20, 30	100	80	3.4(3.06)	2.2(1.98)	150
BWVS00606045180□00	18	20, 30	100	100	3.1(2.79)	1.8(1.62)	180
BWVS00606045220□00	22	20, 30	100	125	3.0(2.70)	1.9(1.71)	220
BWVS00606045270□00	27	20, 30	100	160	2.5(2.25)	1.3(1.17)	270
BWVS00606045330□00	33	20, 30	100	165	2.3(2.07)	1.4(1.26)	330
BWVS00606045470□00	47	20, 30	100	245	1.9(1.71)	1.2(1.08)	470
BWVS00606045560□00	56	20, 30	100	310	1.7(1.50)	1.1(0.99)	560
BWVS00606045680□00	68	20, 30	100	330	1.6(1.44)	1.0(0.90)	680
BWVS00606045101□00	100	20, 30	100	500	1.3(1.17)	0.8(0.72)	101
BWVS00606045221□00	220	20, 30	100	1300	0.82(0.73)	0.38(0.34)	221
BWVS00606045331□00	330	20, 30	100	1800	0.7(0.63)	0.35(0.31)	331
BWVS00606045102□00	1000	20, 30	100	6000	0.4(0.36)	0.22(0.19)	102

Note: When ordering, please specify tolerance code. Tolerance: M=±20% , T =±30%

- Operating temperature range - 55°C ~ 125°C(Including self - temperature rise)
- Isat for Inductance drop 30% from its value without current
- I rms for a 40°C temperature rise from 25°C ambient with current
- Measure Equipment :
 L : Agilent HP4284A+Agilent HP42841A, 100kHz 1V
 RDC : DIGITAL MILLINHM METER CHROMA 16502, or equivalent
 Isat & I rms : Agilent HP4284A

Test Instruments : HP4284A Material/Impedance Analyzer

Inductance vs. DC Current

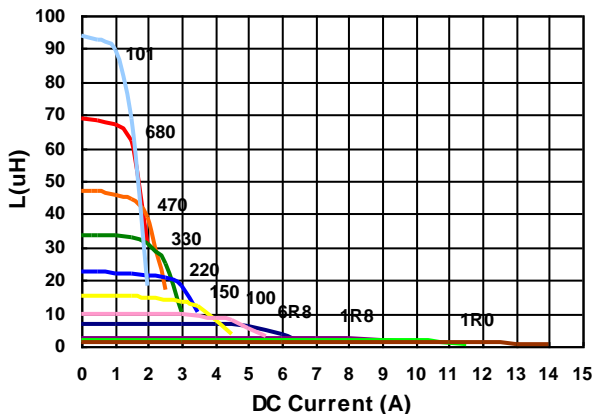

Temperature Change vs. DC Current

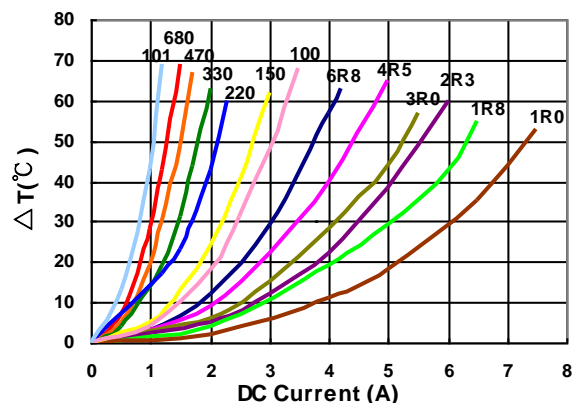

Sealed Power Inductors - BWVS Series

Electrical Characteristics

Part Number	Inductance (uH)	Tolerance (±%)	Test Frequency (kHz)	RDC (mΩ) Max	Isat (A) Typ. (Max)	Irms (A) Typ. (Max)	Marking
BWVS00606045R50□L1	0.5	30	100	9	11(9.90)	8.0(7.20)	R50
BWVS006060452R2□L1	2.2	20, 30	100	17	6.8(6.12)	5.5(4.95)	2R2
BWVS006060453R3□L1	3.3	20, 30	100	24	5.5(4.95)	4.7(4.23)	3R3
BWVS006060454R7□L1	4.7	20, 30	100	30	4.6(4.14)	4.0(3.60)	4R7
BWVS006060456R8□L1	6.8	20, 30	100	40	4.0(3.60)	3.5(3.15)	6R8
BWVS00606045100□L1	10	20, 30	100	50	3.2(2.88)	3.2(2.88)	100
BWVS00606045150□L1	15	20, 30	100	80	2.6(2.34)	2.5(2.25)	150
BWVS00606045220□L1	22	20, 30	100	120	2.1(1.89)	2.0(1.80)	220
BWVS00606045330□L1	33	20, 30	100	170	1.7(1.53)	1.6(1.44)	330
BWVS00606045101□L1	100	20, 30	100	595	0.95(0.85)	0.92(0.82)	101

Note: When ordering, please specify tolerance code. Tolerance: M=±20% , T =±30%

- Operating temperature range - 55°C ~ 125°C(Including self - temperature rise)
- Isat for Inductance drop 30% from its value without current
- I rms for a 40°C temperature rise from 25°C ambient with current
- Measure Equipment :
 L : Agilent HP4284A+Agilent HP42841A, 100kHz 1V
 RDC : DIGITAL MILLINHM METER CHROMA 16502, or equivalent
 Isat & I rms : Agilent HP4284A

Test Instruments : HP4284A Material/Impedance Analyzer

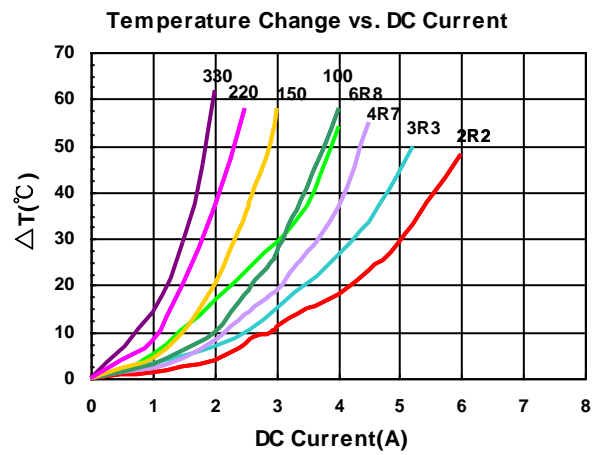
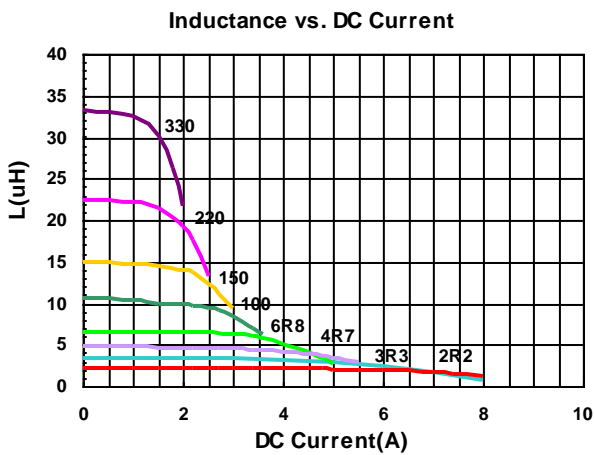

Sealed Power Inductors - BWVS Series

Electrical Characteristics

Part Number	Inductance (uH)	Tolerance (±%)	Test Frequency (kHz)	RDC (mΩ) ±30%	Isat (A) Typ. (Max)	Irms (A) Typ. (Max)	Marking
BWVS00808040R9□00	0.9	30	100	7	13.8(12.42)	8.05(7.24)	R90
BWVS008080401R0□00	1.0	30	100	7.5	13.0(11.70)	7.95(7.15)	1R0
BWVS008080401R4□00	1.4	30	100	9	10.8(9.72)	7.8(7.02)	1R4
BWVS008080401R5□00	1.5	30	100	9.5	10.0(9.00)	7.7(6.93)	1R5
BWVS008080402R0□00	2.0	20, 30	100	11	9.6(8.64)	7.4(6.66)	2R0
BWVS008080402R2□00	2.2	20, 30	100	11.5	9.2(8.28)	7.2(6.48)	2R2
BWVS008080402R5□00	2.5	20, 30	100	13	8.2(7.38)	6.3(5.67)	2R5
BWVS008080403R3□00	3.3	20, 30	100	15	7.5(6.75)	6.0(5.40)	3R3
BWVS008080403R9□00	3.9	20, 30	100	18	6.1(5.40)	5.5(4.90)	3R9
BWVS008080404R7□00	4.7	20, 30	100	18	6.0(5.40)	5.5(4.95)	4R7
BWVS008080405R6□00	5.6	20, 30	100	23	5.7(5.13)	5.2(4.68)	5R6
BWVS008080406R8□00	6.8	20, 30	100	25	5.4(4.86)	5.1(4.59)	6R8
BWVS00808040100□00	10	20, 30	100	38	4.3(3.87)	3.8(3.42)	100
BWVS00808040120□00	12	20, 30	100	45	3.8(3.42)	3.5(3.15)	120
BWVS00808040150□00	15	20, 30	100	50	3.6(3.24)	3.2(2.88)	150
BWVS00808040180□00	18	20, 30	100	68	3.1(2.79)	2.7(2.43)	180
BWVS00808040220□00	22	20, 30	100	80	2.8(2.52)	2.6(2.34)	220
BWVS00808040330□00	33	20, 30	100	110	2.3(2.07)	2.0(1.80)	330
BWVS00808040470□00	47	20, 30	100	160	1.9(1.71)	1.75(1.57)	470
BWVS00808040680□00	68	20, 30	100	240	1.7(1.53)	1.45(1.30)	680
BWVS00808040101□00	100	20, 30	100	340	1.4(1.26)	1.10(0.99)	101
BWVS00808040121□00	120	20, 30	100	425	1.1(0.99)	1.0(0.90)	121
BWVS00808040151□00	150	20, 30	100	480	1.0(0.90)	0.9(0.81)	151
BWVS00808040181□00	180	20, 30	100	650	0.98(0.88)	0.7(0.63)	181
BWVS00808040221□00	220	20, 30	100	670	0.94(0.84)	0.60(0.54)	221
BWVS00808040271□00	270	20, 30	100	900	0.83(0.74)	0.55(0.49)	271
BWVS00808040821□00	820	20, 30	100	2800	0.40(0.36)	0.38(0.34)	821

Note: When ordering, please specify tolerance code. Tolerance: M=±20% , T =±30%

- Operating temperature range - 55°C ~ 125°C(Including self - temperature rise)
- Isat for Inductance drop 30% from its value without current
- Irms for a 40°C temperature rise from 25°C ambient with current
- Measure Equipment :
 L : Agilent HP4284A+Agilent HP42841A, 100kHz 1V
 RDC : DIGITAL MILLINHM METER CHROMA 16502, or equivalent
 Isat & Irms : Agilent HP4284A

Test Instruments : HP4284A Material/Impedance Analyzer

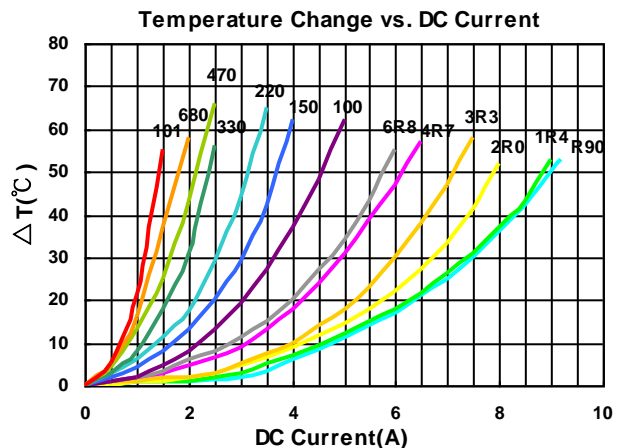
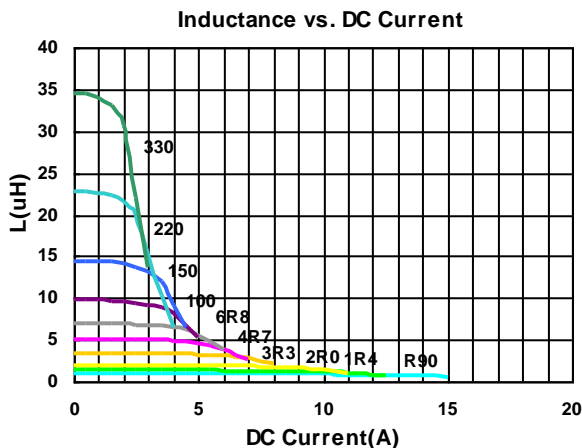

Please be sure to request approval specifications that provide further details of the products. Kindly note that the content of these specifications are subject to change or may be discontinued without prior notice. This product may not be designed/used in medical or high risk applications without Chilisin approval. Please contact our sales department before ordering.



CHILISIN ELECTRONICS CORP.

Sealed Power Inductors - BWVS Series

Electrical Characteristics

Part Number	Inductance (uH)	Tolerance (±%)	Test Frequency (kHz)	RDC (mΩ) Max	Isat (A) Typ. (Max)	Irms (A) Typ. (Max)	Marking
BWVS008080401R0□L1	1.0	30	100	10	9.5(8.55)	8.5(7.65)	1R0
BWVS008080402R2□L1	2.2	20,30	100	12	7.2(6.48)	7.3(6.57)	2R2
BWVS008080403R3□L1	3.3	20,30	100	19	5.6(5.04)	6.0(5.40)	3R3
BWVS008080404R7□L1	4.7	20,30	100	22	4.4(3.96)	5.0(4.50)	4R7
BWVS008080408R2□L1	8.2	20,30	100	37	3.6(3.24)	3.8(3.42)	8R2
BWVS00808040100□L1	10	20,30	100	42	3.1(2.79)	3.5(3.15)	100
BWVS00808040150□L1	15	20,30	100	58	2.5(2.25)	3.0(2.70)	150
BWVS00808040220□L1	22	20,30	100	85	2.0(1.80)	2.5(2.25)	220

Note: When ordering, please specify tolerance code. Tolerance: M=±20% , T =±30%

- Operating temperature range - 55°C ~ 125°C(Including self - temperature rise)
- Isat for Inductance drop 30% from its value without current
- I rms for a 40°C temperature rise from 25°C ambient with current
- Measure Equipment :
 L : Agilent HP4284A+Agilent HP42841A, 100kHz 1V
 RDC : DIGITAL MILLINHM METER CHROMA 16502, or equivalent
 Isat & I rms : Agilent HP4284A

Test Instruments : HP4284A Material/Impedance Analyzer

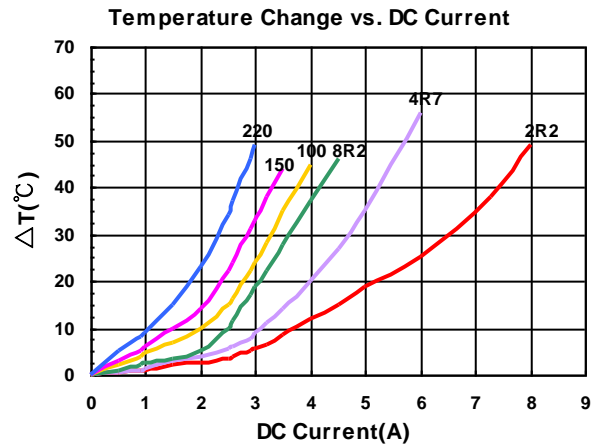
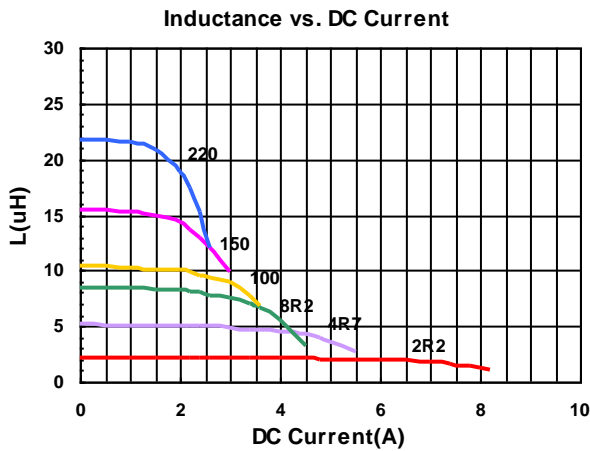

Sealed Power Inductors - BWVS Series

Packaging Specifications

Tape Dimensions

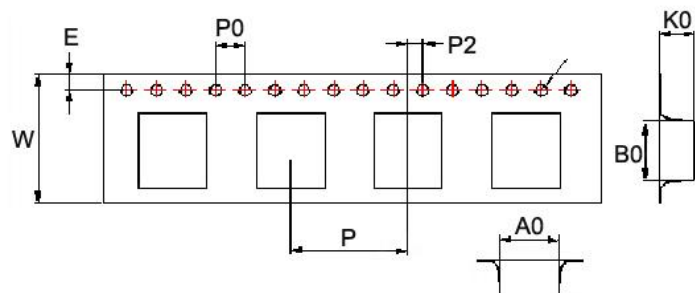

Reel Dimensions

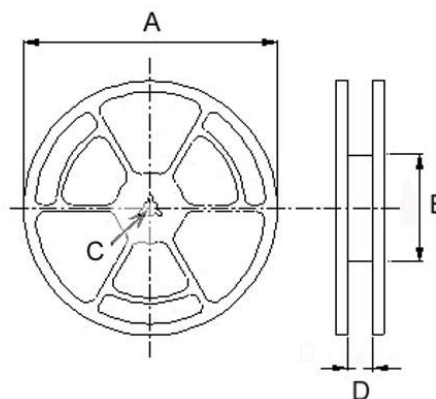

Dimensions in mm

TYPE	Tape Dimensions										Reel Dimensions				Quantity PCS / Reel
	A0	B0	K0	D	E	F	W	P	P0	P2	A	B	C	D	
BWVS00404012	4.25	4.25	1.30	1.55	1.75	5.5	12	8	4	2	180	60	13	13.2	1000
BWVS00404018	4.25	4.25	2.10	1.55	1.75	5.5	12	8	4	2	180	60	13	13.2	800
BWVS00404026	4.25	4.25	3.00	1.55	1.75	5.5	12	8	4	2	180	60	13	13.2	500
BWVS00505020	5.25	5.25	2.20	1.55	1.75	5.5	12	8	4	2	330	100	13	13.4	2000
BWVS00505040	5.20	5.20	4.20	1.55	1.75	5.5	12	8	4	2	330	100	13	13.4	1500
BWVS00606020	6.25	6.25	2.20	1.55	1.75	7.5	16	12	4	2	330	100	13	16.0	2000
BWVS00606028	6.25	6.25	3.00	1.55	1.75	7.5	16	12	4	2	330	100	13	16.0	1500
BWVS00606045	6.25	6.25	4.65	1.55	1.75	7.5	16	12	4	2	330	100	13	16.0	1000
BWVS00808040	8.25	8.25	4.15	1.55	1.75	7.5	16	12	4	2	330	100	13	16.0	1000