

## BDCL Series



BDCL Series provides high current in compact package size with magnetically shielded construction. This power inductor is an excellent power solution for space-limited devices.

### Features

- RoHS, Halogen Free and REACH Compliance
- Monolithic, magnetically shielded
- Capable for large current

### Applications

- Smartphones, tablets and wearable devices
- HDD, SSD and PC peripheral devices
- DSC, camcoders
- PND
- DC/DC converters

### Product Identification

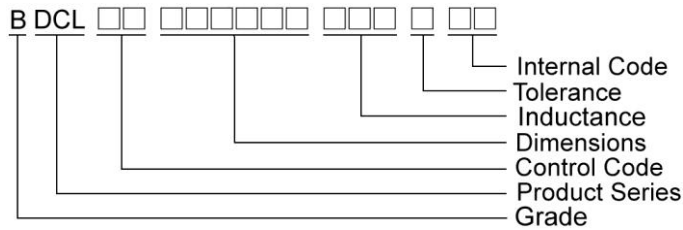

### Shape and Dimensions

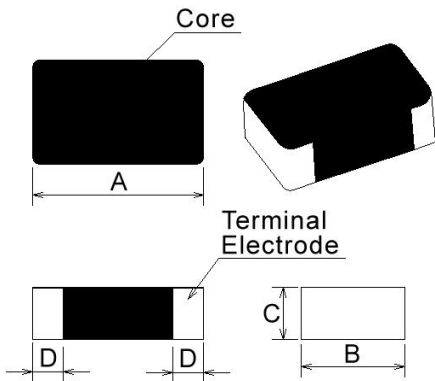

Dimensions in mm

TYPE	A	B	C	D
BDCL00201610	2.0±0.2	1.6±0.2	1.0Max	0.5±0.3
BDCL00201612	2.0±0.2	1.6±0.2	1.2Max	0.5±0.3
BDCL00252010	2.5±0.2	2.0±0.2	1.0Max	0.6±0.3
BDCL00252012	2.5±0.2	2.0±0.2	1.2Max	0.6±0.3

### Recommended Pattern

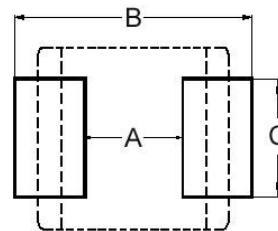

Dimensions in mm

TYPE	A	B	C
BDCL00201610	0.7	2.3	1.8
BDCL00201612	0.7	2.3	1.8
BDCL00252010	1.2	2.8	2.3
BDCL00252012	1.2	2.8	2.3

# Molding Power Inductors – BDCL Series

## Electrical Characteristics

Part Number	Inductance (uH)	Tolerance (±%)	Test Frequency (MHz)	RDC(mΩ) Max(Typ.)	Isat(A) Max(Typ.)	Irms(A) Max(Typ.)
BDCL00201610R24MS1	0.24	20	2	40(28)	4.2(6.0)	4.0(4.5)
BDCL00201610R33MS1	0.33	20	2	48(40)	4.0(5.5)	3.5(3.8)
BDCL00201610R47MS1	0.47	20	2	54(44)	3.2(5.0)	3.0(3.6)
BDCL00201610R56MS1	0.56	20	2	59(46)	2.8(4.6)	2.8(3.3)
BDCL00201610R68MS1	0.68	20	2	72(55)	2.7(4.2)	2.4(3.0)
BDCL002016101R0MS1	1.0	20	2	96(81)	2.2(3.4)	2.0(2.3)
BDCL002016101R5MS1	1.5	20	2	150(122)	2.1(2.8)	1.6(2.0)
BDCL002016102R2MS1	2.2	20	2	204(170)	2.0(2.4)	1.3(1.6)

**Note: When ordering, please specify tolerance code. Tolerance: M=±20%**

- Operating temperature range - 40°C ~ 125°C(Including self - temperature rise)
- Isat for Inductance drop 30% from its value without current
- I rms for a 40°C temperature rise from 25°C ambient with current
- Rated current : Isat or I rms, whichever is smaller
- Absolute maximum voltage 20VDC
- Measure Equipment :  
 L : Agilent E4991/HP4286A+16197A (or equivalent), 2MHz 0.2V  
 RDC : CHEN HWA502BC/HP4338B (or equivalent)  
 Isat : Agilent E4980A+HP42841A (or equivalent)  
 I rms : Agilent 6641 SYSTEM DC POWER SUPPLY (or equivalent)

**Test Instruments :** E4991A Impedance / Material Analyzer

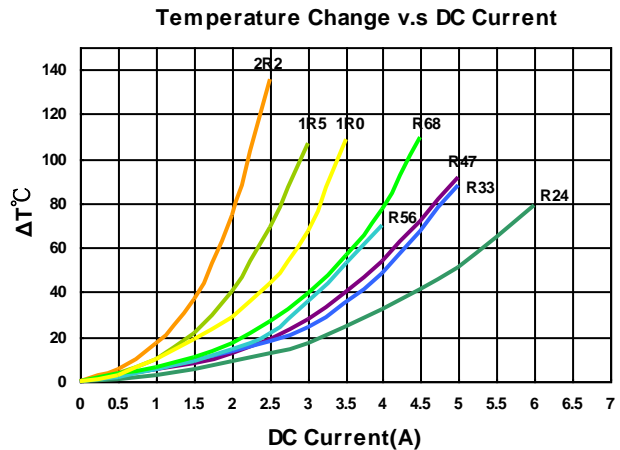
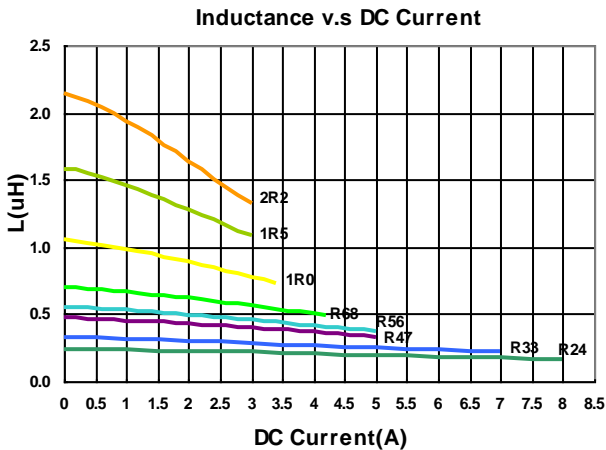

# Molding Power Inductors – BDCL Series

## Electrical Characteristics

Part Number	Inductance (uH)	Tolerance (±%)	Test Frequency (MHz)	RDC(mΩ) Max(Typ.)	Isat(A) Max(Typ.)	Irms(A) Max(Typ.)
BDCL00201610R24ML1	0.24	20	2	30(23)	5.0(6.0)	3.8(4.4)
BDCL00201610R47ML1	0.47	20	2	41(34)	4.0(4.5)	2.9(3.3)
BDCL00201610R68ML1	0.68	20	2	53(44)	3.3(3.6)	2.5(2.9)
BDCL002016101R0ML1	1.0	20	2	72(60)	2.8(3.2)	2.2(2.5)
BDCL002016102R2ML1	2.2	20	2	170(142)	1.8(2.1)	1.5(1.7)

**Note: When ordering, please specify tolerance code. Tolerance: M=±20%**

- Operating temperature range - 40°C ~ 125°C(Including self - temperature rise)
- Isat for Inductance drop 30% from its value without current
- I rms for a 40°C temperature rise from 25°C ambient with current
- Rated current : Isat or I rms, whichever is smaller
- Absolute maximum voltage 20VDC
- Measure Equipment :  
 L : Agilent E4991/HP4286A+16197A (or equivalent), 2MHz 0.2V  
 RDC : CHEN HWA502BC/HP4338B (or equivalent)  
 Isat : Agilent E4980A+HP42841A (or equivalent)  
 I rms : Agilent 6641 SYSTEM DC POWER SUPPLY (or equivalent)

**Test Instruments :** E4991A Impedance / Material Analyzer

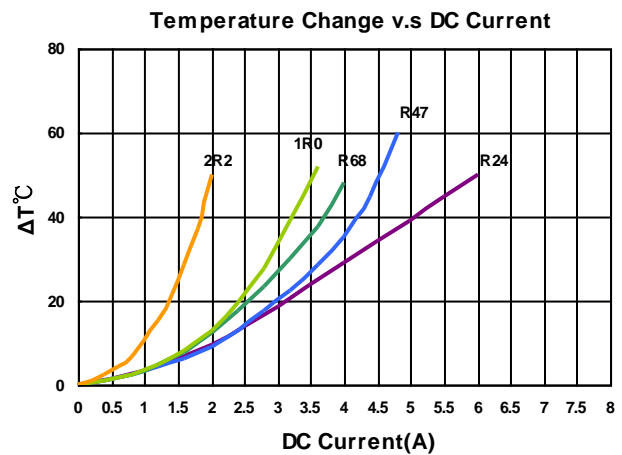
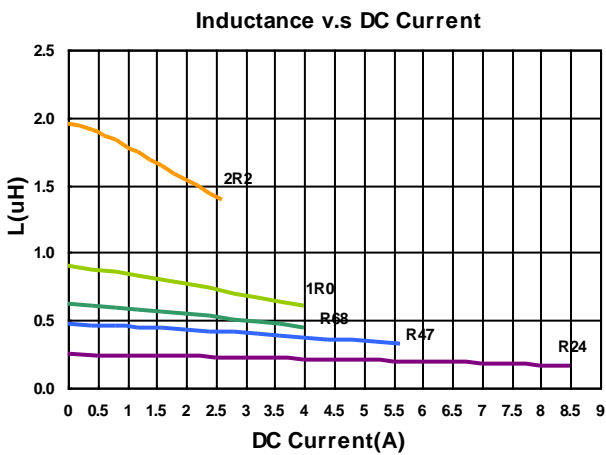

# Molding Power Inductors – BDCL Series

## Electrical Characteristics

Part Number	Inductance (uH)	Tolerance (±%)	Test Frequency (MHz)	RDC(mΩ) Max(Typ.)	Isat(A) Max(Typ.)	Irms(A) Max(Typ.)
BDCL00201612R24MS1	0.24	20	2	35(25)	5.5(6.5)	4.2(4.8)
BDCL00201612R47MS1	0.47	20	2	52(40)	3.8(5.1)	3.2(3.8)
BDCL00201612R68MS1	0.68	20	2	70(53)	3.3(4.8)	2.6(3.2)
BDCL002016121R0MS1	1.0	20	2	82(67)	3.1(3.9)	2.3(2.7)
BDCL002016121R5MS1	1.5	20	2	120(95)	2.6(3.2)	2.2(2.6)
BDCL002016122R2MS1	2.2	20	2	195(165)	2.0(2.6)	1.3(1.7)

**Note: When ordering, please specify tolerance code. Tolerance: M=±20%**

- Operating temperature range - 40°C ~ 125°C(Including self - temperature rise)
- Isat for Inductance drop 30% from its value without current
- I rms for a 40°C temperature rise from 25°C ambient with current
- Rated current : Isat or I rms, whichever is smaller
- Absolute maximum voltage 20VDC
- Measure Equipment :
  - L : Agilent E4991/HP4286A+16197A (or equivalent), 2MHz 0.2V
  - RDC : CHEN HWA502BC/HP4338B (or equivalent)
  - Isat : Agilent E4980A+HP42841A (or equivalent)
  - I rms : Agilent 6641 SYSTEM DC POWER SUPPLY (or equivalent)

## Test Instruments : E4991A Impedance / Material Analyzer

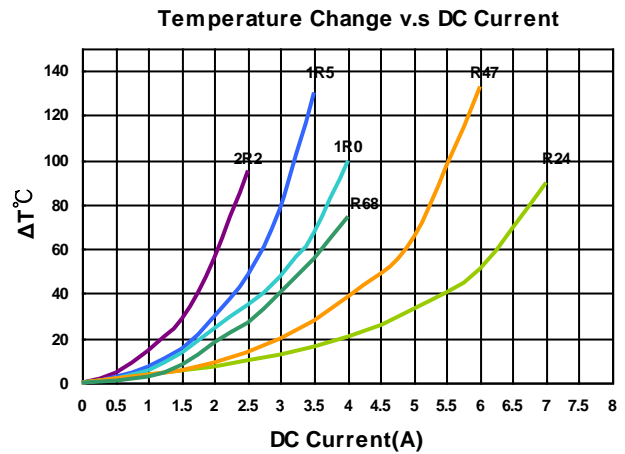
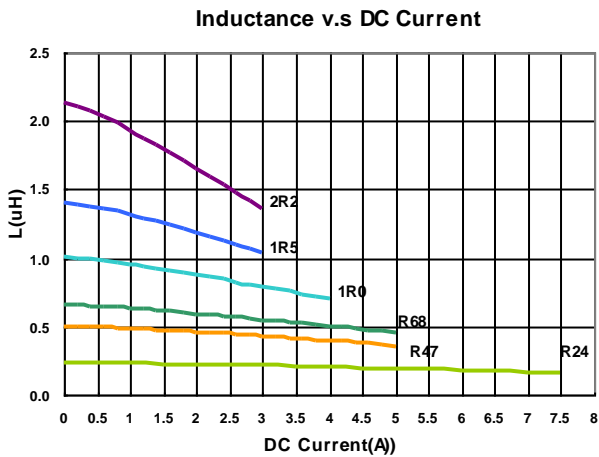

# Molding Power Inductors – BDCL Series

## Electrical Characteristics

Part Number	Inductance (uH)	Tolerance (±%)	Test Frequency (MHz)	RDC(mΩ) Max(Typ.)	Isat(A) Max(Typ.)	Irms(A) Max(Typ.)
BDCL00252010R24MS1	0.24	20	2	40(24)	7.5(9.5)	4.5(5.0)
BDCL00252010R47MS1	0.47	20	2	46(36)	5.2(6.5)	3.1(3.6)
BDCL00252010R68MS1	0.68	20	2	65(49)	3.8(5.0)	2.9(3.3)
BDCL002520101R0MS1	1.0	20	2	78(60)	3.4(4.3)	2.5(3.0)
BDCL002520101R5MS1	1.5	20	2	105(82)	3.2(4.0)	2.2(2.9)
BDCL002520102R2MS1	2.2	20	2	156(130)	2.6(3.2)	1.4(1.8)

**Note: When ordering, please specify tolerance code. Tolerance: M=±20%**

- Operating temperature range - 40°C ~ 125°C(Including self - temperature rise)
- Isat for Inductance drop 30% from its value without current
- I rms for a 40°C temperature rise from 25°C ambient with current
- Rated current : Isat or I rms, whichever is smaller
- Absolute maximum voltage 20VDC
- Measure Equipment :  
 L : Agilent E4991/HP4286A+16197A (or equivalent), 2MHz 0.2V  
 RDC : CHEN HWA502BC/HP4338B (or equivalent)  
 Isat : Agilent E4980A+HP42841A (or equivalent)  
 I rms : Agilent 6641 SYSTEM DC POWER SUPPLY (or equivalent)

**Test Instruments : E4991A Impedance / Material Analyzer**

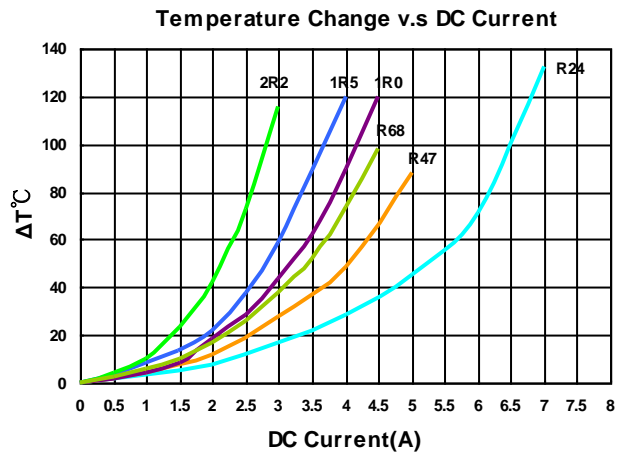
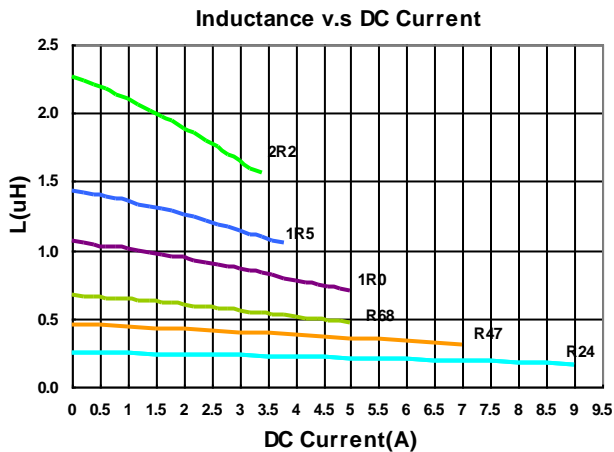

# Molding Power Inductors – BDCL Series

## Electrical Characteristics

Part Number	Inductance (uH)	Tolerance (±%)	Test Frequency (MHz)	RDC(mΩ) Max(Typ.)	Isat(A) Max(Typ.)	Irms(A) Max(Typ.)
BDCL00252010R33ML1	0.33	20	2	31(25)	5.0(6.0)	3.8(4.4)
BDCL00252010R47ML1	0.47	20	2	35(29)	4.2(4.7)	3.4(3.9)
BDCL00252010R68ML1	0.68	20	2	48(40)	3.7(4.0)	3.0(3.5)
BDCL002520101R0ML1	1.0	20	2	65(54)	3.2(3.6)	2.6(3.0)
BDCL002520101R5ML1	1.5	20	2	94(78)	2.9(3.3)	2.1(2.4)
BDCL002520102R2ML1	2.2	20	2	120(100)	2.3(2.7)	1.8(2.1)

**Note: When ordering, please specify tolerance code. Tolerance: M=±20%**

- Operating temperature range - 40°C ~ 125°C(Including self - temperature rise)
- Isat for Inductance drop 30% from its value without current
- I rms for a 40°C temperature rise from 25°C ambient with current
- Rated current : Isat or I rms, whichever is smaller
- Absolute maximum voltage 20VDC
- Measure Equipment :  
 L : Agilent E4991/HP4286A+16197A (or equivalent), 2MHz 0.2V  
 RDC : CHEN HWA502BC/HP4338B (or equivalent)  
 Isat : Agilent E4980A+HP42841A (or equivalent)  
 I rms : Agilent 6641 SYSTEM DC POWER SUPPLY (or equivalent)

**Test Instruments :** E4991A Impedance / Material Analyzer

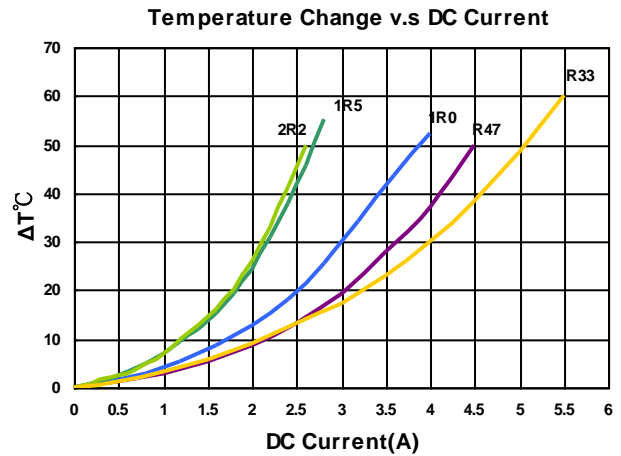
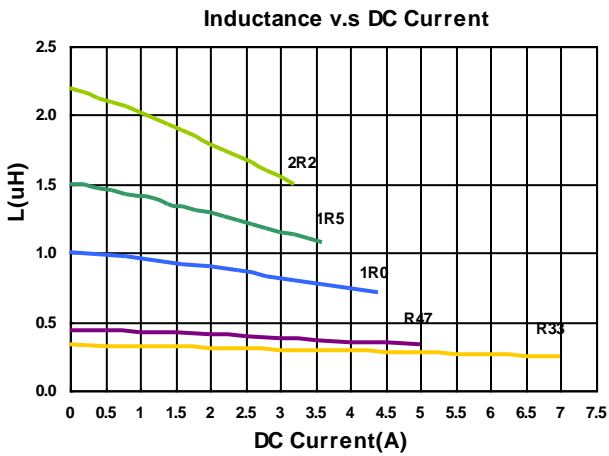

# Molding Power Inductors – BDCL Series

## Electrical Characteristics

Part Number	Inductance (uH)	Tolerance (±%)	Test Frequency (MHz)	RDC(mΩ) Max(Typ.)	Isat(A) Max(Typ.)	Irms(A) Max(Typ.)
BDCL00252012R33MS1	0.33	20	2	35(27)	6.8(8.5)	4.0(4.6)
BDCL00252012R47MS1	0.47	20	2	39(29)	6.2(7.8)	3.7(4.4)
BDCL00252012R68MS1	0.68	20	2	46(40)	5.5(6.5)	3.3(3.7)
BDCL002520121R0MS1	1.0	20	2	59(45)	4.0(5.0)	3.0(3.5)
BDCL002520121R5MS1	1.5	20	2	70(62)	3.4(4.0)	2.5(2.7)
BDCL002520122R2MS1	2.2	20	2	115(102)	3.3(3.8)	2.0(2.3)

**Note: When ordering, please specify tolerance code. Tolerance: M=±20%**

- Operating temperature range - 40°C ~ 125°C(Including self - temperature rise)
- Isat for Inductance drop 30% from its value without current
- I rms for a 40°C temperature rise from 25°C ambient with current
- Rated current : Isat or I rms, whichever is smaller
- Absolute maximum voltage 20VDC
- Measure Equipment :  
 L : Agilent E4991/HP4286A+16197A (or equivalent), 2MHz 0.2V  
 RDC : CHEN HWA502BC/HP4338B (or equivalent)  
 Isat : Agilent E4980A+HP42841A (or equivalent)  
 I rms : Agilent 6641 SYSTEM DC POWER SUPPLY (or equivalent)

**Test Instruments :** E4991A Impedance / Material Analyzer

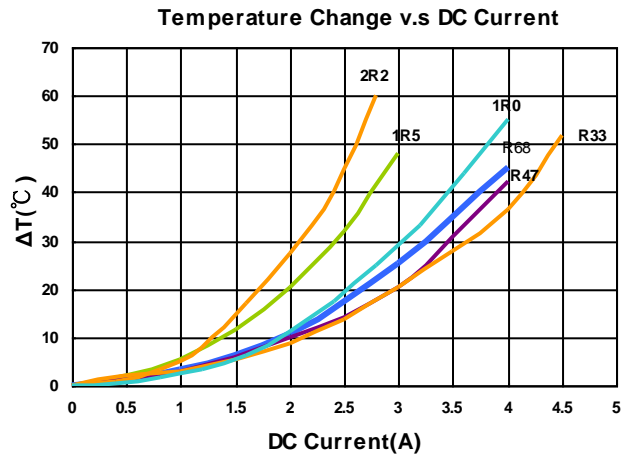
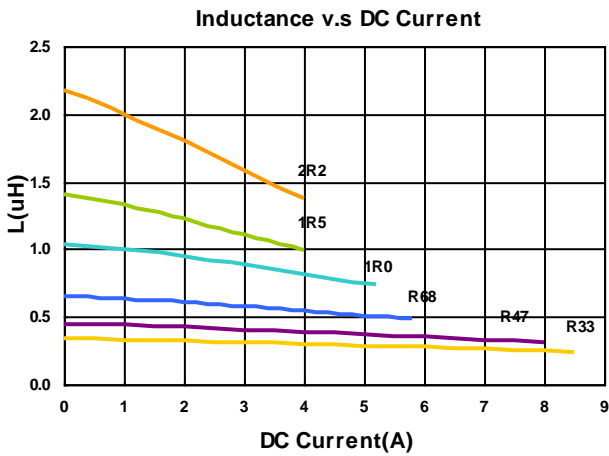

# Molding Power Inductors – BDCL Series

## Electrical Characteristics

Part Number	Inductance (uH)	Tolerance (±%)	Test Frequency (MHz)	RDC(mΩ) Max(Typ.)	Isat(A) Max(Typ.)	Irms(A) Max(Typ.)
BDCL00252012R47ML1	0.47	20	2	34(30)	5.2(6.0)	4.1(4.7)
BDCL002520121R0ML1	1.0	20	2	56(45)	3.6(4.5)	3.2(3.7)
BDCL002520122R2ML1	2.2	20	2	102(80)	2.5(3.0)	2.2(2.6)

**Note: When ordering, please specify tolerance code. Tolerance: M=±20%**

- Operating temperature range - 40°C ~ 125°C(Including self - temperature rise)
- Isat for Inductance drop 30% from its value without current
- Irms for a 40°C temperature rise from 25°C ambient with current
- Rated current : Isat or Irms, whichever is smaller
- Absolute maximum voltage 20VDC
- Measure Equipment :
  - L : Agilent E4991/HP4286A+16197A (or equivalent), 2MHz 0.2V
  - RDC : CHEN HWA502BC/HP4338B (or equivalent)
  - Isat : Agilent E4980A+HP42841A (or equivalent)
  - Irms : Agilent 6641 SYSTEM DC POWER SUPPLY (or equivalent)

## Test Instruments : E4991A Impedance / Material Analyzer

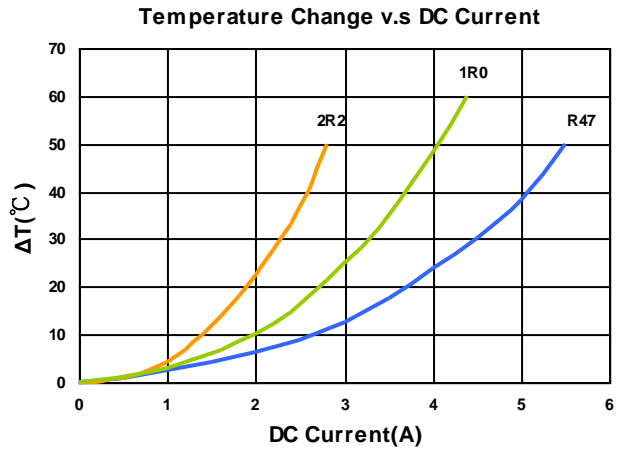
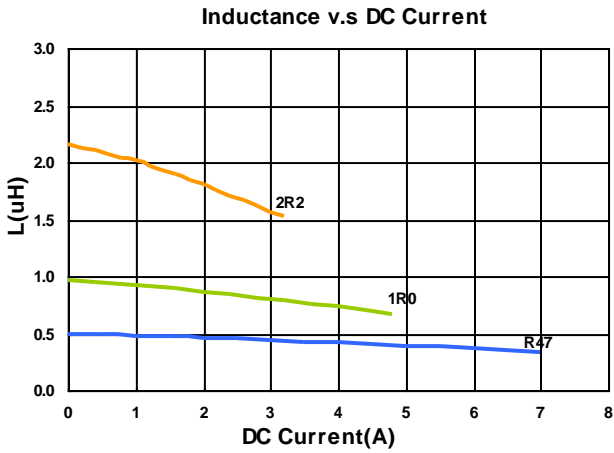



## Packaging Specifications

Tape Dimensions

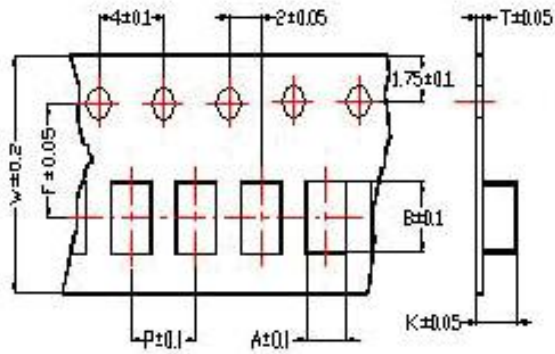

Tape Material

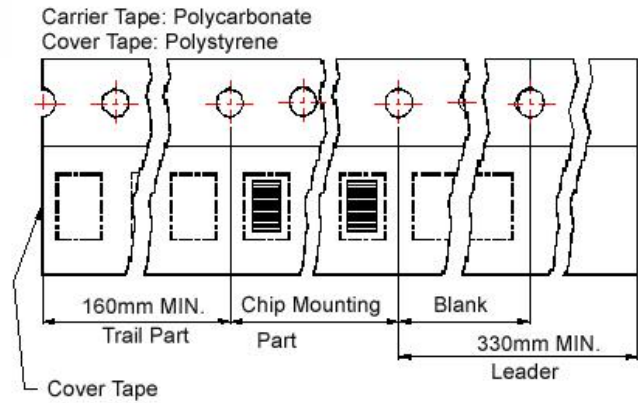

Reel Dimensions

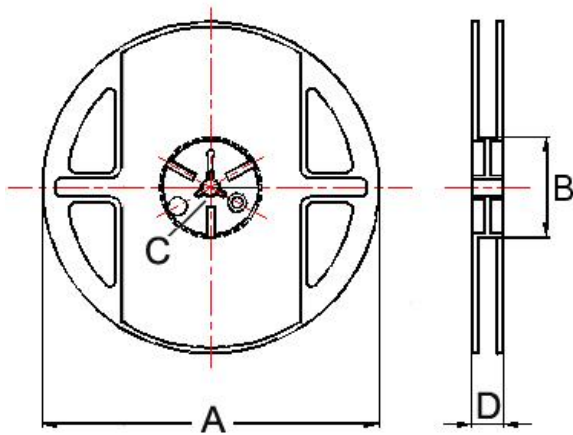

Dimensions in mm

TYPE	Tape Dimensions							Reel Dimensions				Quantity PCS / REEL
	A	B	T	W	P	F	K	A	B	C	D	
BDCL00201610	1.80	2.20	0.22	8	4	3.5	1.15	178	60	12	1.5	3000
BDCL00201612	1.80	2.20	0.22	8	4	3.5	1.15	178	60	12	1.5	3000
BDCL00252010	2.25	2.80	0.22	8	4	3.5	1.15	178	60	12	1.5	3000
BDCL00252012	2.25	2.80	0.22	8	4	3.5	1.35	178	60	12	1.5	3000