

Data Sheet

Customer:

Product: SMD Wire Wound Chip Inductor-WL Series

Sizes.: 0402/0603/0805/1008/1206

Issued Date: 01-Nov-18

Edition: REV.C8



VIKING TECH CORPORATION
光韻科技股份有限公司
No.70 Guangfu N. Rd., Hukou
Township, Hsinchu County 303,
Taiwan

TEL:886-3-5972931
FAX:886-3-5972935•886-3-5973494
E-mail:sales@viking.com.tw

VIKING TECH CORPORATION KAOHSIUNG BRANCH
光韻科技股份有限公司高雄分公司
No.248-3, Sin-Sheng Rd., Cian-Jhen Dist., Kaohsiung,
806, Taiwan

TEL:886-7-8217999
FAX:886-7-8228229
E-mail:sales@viking.com.tw

WUXI TMTEC CO., LTD.
無錫泰銘電子有限公司
No.22 Xixia Road, Machinery & Industry Park,
National Hi-Tech Industrial Development Zone
of Wuxi, Wuxi, Jiangsu Province, China
Zip Code:214028
TEL:86-510-85203339
FAX:86-510-85203667•86-510-85203977
E-mail:china@viking.com.tw

Produced by (QC)	Checked (QC)	Approved by (QC)	Prepared by (Sales)	Accepted by (Customer)
01-Nov-18	01-Nov-18	01-Nov-18		
Susan Huang	J.C. Liu	J.C. Liu		

SMD Wire Wound Chip Inductor

Scope

– Ceramic body and wire wound construction provide highest SRFs available

Features

- Ceramic base provide high SRF
- Ultra-compact inductors provide high Q factors
- Low profile, high current are available
- Miniature SMD chip inductor for fully automated assembly
- Outstanding endurance from Pull-up force, mechanical shock and pressure
- Tighter tolerance down to $\pm 2\%$
- Smaller size of 0402 (1005)
- AEC-Q200 Compliance (Standard Type except Size 1206)



Applications

RF Products:

- Cellular Phone (CDMA/GSM/PHS)
- Cordless Phone (DECT/CT1CT2)
- Remote Control, Security System
- Wireless PDA
- WLL, Wireless LAN / Mouse / Keyboard / Earphone
- VCO, RF Module & Other Wireless Products
- Base Station, Repeater
- GPS Receiver

Broad Band Applications:

- CATV Filter, Tuner
- Cable Modem/ XDSL Tuner
- Set Top Box

IT Applications:

- USB 2.0
- IEEE 1394

Construction

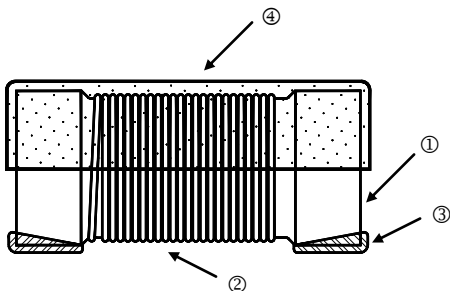

① Ceramic Core	③ Electrode
② Magnet Wire	④ UV Glue

SMD Wire Wound Chip Inductor

■ Dimensions

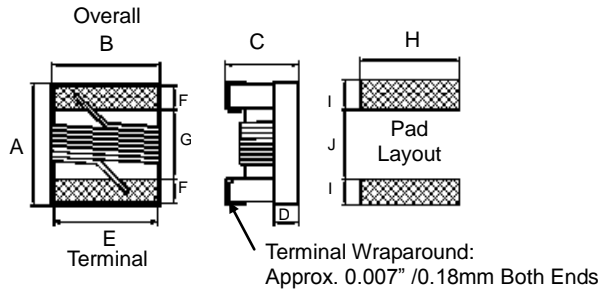

Standard

Unit: mm

Type	Size (Inch)	A max.	B max.	C max.	D Ref.	E	F	G	H	I	J	Weight (g) (1000pcs)
WL02	0402	1.27	0.76	0.61	0.15	0.51	0.23	0.56	0.66	0.50	0.46	0.8
WL03	0603	1.80	1.12	1.02	0.38	0.76	0.33	0.86	1.02	0.64	0.64	3.46
WL05	0805	2.29	1.73	1.52	0.51	1.27	0.44	1.02	1.78	1.02	0.76	12.13
WL08	1008	2.92	2.79	2.13	0.65	2.03	0.51	1.52	2.54	1.02	1.27	30.73
WL06	1206	3.56	2.16	1.52	0.51	1.62	0.51	2.20	1.93	1.02	1.80	40

High Current / High Q

Unit: mm

Type	Size (Inch)	A max.	B max.	C max.	D Ref.	E	F	G	H	I	J
WL02	0402	1.27	0.76	0.61	0.15	0.51	0.23	0.56	0.66	0.50	0.46
WL03	0603	1.80	1.12	1.02	0.38	0.76	0.33	0.86	1.02	0.64	0.64
WL05	0805	2.29	1.73	1.52	0.51	1.27	0.44	1.02	1.78	1.02	0.76
WL08	1008	2.92	2.79	2.03	0.65	2.03	0.51	1.52	2.54	1.02	1.27

■ Part Numbering

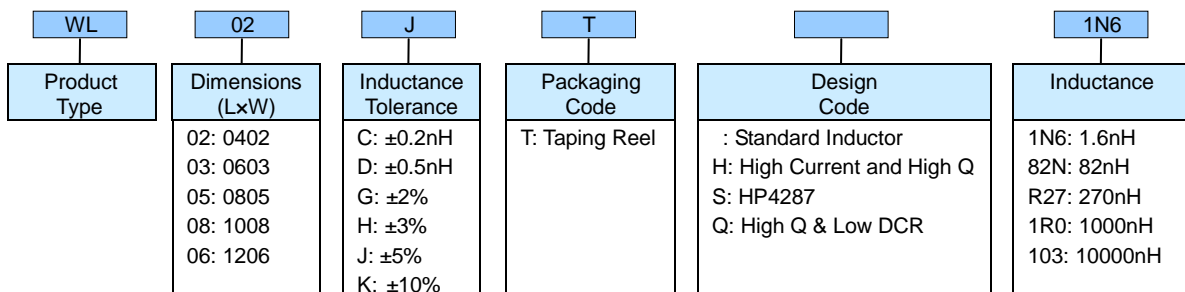

Standard Electrical Specifications

WL02 Wire Wound Chip Inductors / Standard Type

Inductance (nH)	Tolerance	L Freq. (MHz)	Quality Factor min.	SRF (GHz) min.	DCR (Ω) max.	IDC (mA) max.	900MHz		1.7GHz	
							L	Q	L	Q
1.0	±10%	250	16	12.70	0.045	1360	1.02	77	1.02	69
1.9	±10%	250	16	11.30	0.070	1040	1.72	68	1.74	82
2.0	±10%	250	16	11.10	0.070	1040	1.93	54	1.93	75
2.2	±10%	250	19	10.80	0.070	960	2.19	59	2.23	100
2.4	±10%	250	15	10.50	0.070	790	2.24	51	2.27	68
2.7	±10%	250	16	10.40	0.120	640	2.23	42	2.25	61
3.3	±10%	250	19	7.00	0.066	840	3.10	65	3.12	87
3.6	±5, ±10%	250	19	6.80	0.066	840	3.56	45	3.62	71
3.9	±5, ±10%	250	19	5.80	0.066	840	3.89	50	4.00	75
4.3	±5, ±10%	250	18	6.00	0.091	700	4.19	47	4.30	71
4.7	±5, ±10%	250	18	4.70	0.130	640	4.55	48	4.68	68
5.1	±5, ±10%	250	20	4.80	0.083	800	5.15	56	5.25	82
5.6	±5, ±10%	250	20	4.80	0.083	760	5.16	54	5.28	81
6.2	±5, ±10%	250	20	4.80	0.083	760	6.16	52	6.37	76
6.8	±5, ±10%	250	20	4.80	0.083	680	6.56	63	6.93	78
7.5	±5, ±10%	250	22	4.80	0.104	680	7.91	60	8.22	88
8.2	±5, ±10%	250	22	4.40	0.104	680	8.50	57	8.85	84
8.7	±5, ±10%	250	18	4.10	0.200	480	8.78	54	9.21	73
9.0	±5, ±10%	250	22	4.16	0.104	680	9.07	62	9.53	78
9.5	±5, ±10%	250	18	4.00	0.200	480	9.42	54	9.98	69
10	±2, ±5, ±10%	250	21	3.90	0.195	480	9.80	50	10.10	67
11	±2, ±5, ±10%	250	24	3.68	0.120	640	10.70	52	11.20	78
12	±2, ±5, ±10%	250	24	3.60	0.120	640	11.90	53	12.70	71
13	±2, ±5, ±10%	250	24	3.45	0.210	440	13.40	51	14.60	57
15	±2, ±5, ±10%	250	24	3.28	0.172	560	14.60	55	15.50	77
16	±2, ±5, ±10%	250	24	3.10	0.220	560	16.60	46	18.80	47
18	±2, ±5, ±10%	250	25	3.10	0.230	420	18.30	57	20.30	62
19	±2, ±5, ±10%	250	24	3.04	0.202	480	19.10	50	21.10	67
20	±2, ±5, ±10%	250	25	3.00	0.250	420	20.70	52	23.70	53
22	±2, ±5, ±10%	250	25	2.80	0.300	400	23.20	53	26.80	53
23	±2, ±5, ±10%	250	24	2.72	0.300	400	23.80	49	26.90	64
24	±2, ±5, ±10%	250	25	2.70	0.300	400	25.10	51	29.50	50
27	±2, ±5, ±10%	250	24	2.48	0.300	400	28.70	49	33.50	63
30	±2, ±5, ±10%	250	25	2.35	0.350	400	31.10	46	38.50	39
33	±2, ±5, ±10%	250	24	2.35	0.350	400	34.90	31	41.70	32
36	±2, ±5, ±10%	250	24	2.32	0.440	320	39.50	44	48.40	53
39	±2, ±5, ±10%	250	25	2.10	0.550	200	41.70	47	50.20	45
40	±2, ±5, ±10%	250	24	2.24	0.500	320	39.00	44	47.40	33
43	±2, ±5, ±10%	250	25	2.03	0.810	100	45.80	46	61.60	34
47	±2, ±5, ±10%	250	25	2.10	0.830	150	50.00	38	55.80	37
51	±2, ±5, ±10%	250	25	1.75	0.820	100	50.40	47	59.40	37
56	±2, ±5, ±10%	250	25	1.76	0.970	100	57.40	49	72.40	40
68	±2, ±5, ±10%	250	22	1.62	1.120	100	69.60	45	83.40	38
82	±2, ±5, ±10%	250	22	1.26	1.550	50	-	-	-	-
100	±2, ±5, ±10%	250	22	1.16	2.000	30	-	-	-	-
120	±2, ±5, ±10%	250	20	>1.80	2.660	50	-	-	-	-

WL03 Wire Wound Chip Inductors / Standard Type

Inductance (nH)	Tolerance	L Freq. (MHz)	Quality Factor min.	SRF (GHz) min.	DCR (Ω) max.	IDC (mA) max.	900MHz		1.7GHz	
							L	Q	L	Q
1.6	±5, ±10%	250	24	12.5	0.030	700	1.53	35	1.58	55
1.8	±5, ±10%	250	16	12.5	0.045	700	1.63	35	1.66	50
2.2	±5, ±10%	250	15	6.00	0.100	700	2.18	41	2.20	64
2.3	±5, ±10%	250	16	>4.00	0.140	700	2.32	32	2.35	40
3.3	±2, ±5, ±10%	250	22	>6.00	0.080	700	3.35	47	3.40	65
3.6	±2, ±5, ±10%	250	22	5.80	0.063	700	3.53	49	3.58	65
3.9	±2, ±5, ±10%	250	22	>6.00	0.080	700	3.95	49	3.96	67
4.3	±2, ±5, ±10%	250	22	5.80	0.063	700	4.32	49	4.43	67
4.5	±2, ±5, ±10%	250	20	5.80	0.120	700	4.74	55	4.87	92
4.7	±2, ±5, ±10%	250	25	5.80	0.120	700	4.65	53	4.80	67
5.1	±2, ±5, ±10%	250	20	5.80	0.160	700	5.13	47	5.36	56
5.6	±2, ±5, ±10%	250	20	5.80	0.170	700	5.53	56	5.86	77
6.2	±2, ±5, ±10%	250	25	5.80	0.110	700	6.28	60	6.40	85
6.3	±2, ±5, ±10%	250	25	5.80	0.110	700	6.67	41	6.86	61
6.8	±2, ±5, ±10%	250	27	5.80	0.110	700	6.75	60	7.10	81
7.5	±2, ±5, ±10%	250	28	4.80	0.106	700	7.70	60	7.82	65
8.2	±2, ±5, ±10%	250	27	4.80	0.110	700	8.25	64	8.40	81
8.7	±2, ±5, ±10%	250	28	4.80	0.109	700	8.86	62	9.32	58
9.1	±2, ±5, ±10%	250	35	4.80	0.130	700	9.20	70	9.70	80
9.5	±2, ±5, ±10%	250	28	5.40	0.135	700	9.70	59	9.92	61
10	±2, ±5, ±10%	250	31	4.80	0.130	700	10.0	66	10.6	83
11	±2, ±5, ±10%	250	31	4.00	0.086	700	11.3	53	12.1	56
12	±2, ±5, ±10%	250	35	4.00	0.130	700	12.3	72	13.5	83
15	±2, ±5, ±10%	250	35	4.00	0.170	700	15.4	64	16.8	89
16	±2, ±5, ±10%	250	35	3.30	0.110	700	16.5	55	18.0	52
17	±2, ±5, ±10%	250	35	3.20	0.170	700	17.6	56	19.4	44
18	±2, ±5, ±10%	250	35	3.10	0.170	700	18.7	70	21.4	69
20	±2, ±5, ±10%	250	40	3.00	0.190	700	20.7	80	23.5	30
22	±2, ±5, ±10%	250	38	3.00	0.190	700	22.8	73	26.1	71
23	±2, ±5, ±10%	250	38	2.85	0.190	700	24.1	71	28.0	71
24	±2, ±5, ±10%	250	38	2.80	0.130	700	25.7	45	30.9	40
27	±2, ±5, ±10%	250	40	2.80	0.220	600	29.2	74	34.6	65
30	±2, ±5, ±10%	250	40	2.80	0.150	600	31.4	47	39.8	28
33	±2, ±5, ±10%	250	40	2.30	0.220	600	36.0	67	49.5	42
36	±2, ±5, ±10%	250	37	2.30	0.250	600	39.1	47	48.9	24
39	±2, ±5, ±10%	250	40	2.20	0.250	600	42.7	60	60.2	40
43	±2, ±5, ±10%	200	38	2.00	0.280	600	46.9	44	60.3	21
47	±2, ±5, ±10%	200	38	2.00	0.280	600	52.2	62	77.2	35
51	±2, ±5, ±10%	200	38	1.90	0.280	600	55.5	69	82.2	34
56	±2, ±5, ±10%	200	38	1.90	0.310	600	62.5	56	97.0	26
62	±2, ±5, ±10%	200	37	1.80	0.340	600	68.0	40	110	10
68	±2, ±5, ±10%	200	37	1.70	0.340	600	80.5	54	168	21
72	±2, ±5, ±10%	150	34	1.70	0.490	600	82.0	53	135	20
82	±2, ±5, ±10%	150	34	1.70	0.540	400	96.2	54	177	21
91	±2, ±5, ±10%	150	30	1.70	0.500	400	110.0	50	416.4	6
100	±2, ±5, ±10%	150	34	1.40	0.580	400	124.0	49	319.5	13
110	±2, ±5, ±10%	150	32	1.35	0.610	300	138.0	43	342.7	15
120	±2, ±5, ±10%	150	32	1.30	0.650	300	166.0	39	529.3	8
130	±2, ±5, ±10%	150	30	1.40	0.720	300	185.0	60	-	-
140	±2, ±5, ±10%	100	28	1.30	0.870	280	190.0	80	-	-
150	±2, ±5, ±10%	100	28	1.30	0.950	280	230.0	25	-	-
160	±2, ±5, ±10%	100	25	1.30	1.400	280	215.0	20	-	-
180	±2, ±5, ±10%	100	25	1.25	1.400	250	305.0	22	-	-
220	±2, ±5, ±10%	100	25	1.20	1.600	250	377.0	21	-	-
260	±2, ±5, ±10%	100	25	1.00	2.000	200	469.0	21	-	-
270	±2, ±5, ±10%	100	25	0.90	2.100	200	523.0	19	-	-
280	±2, ±5, ±10%	100	25	1.00	2.400	100	524.0	18	-	-
300	±2, ±5, ±10%	100	25	0.75	2.500	150	539.7	21	-	-
330	±2, ±5, ±10%	100	25	0.90	3.800	100	680.4	20	-	-
390	±2, ±5, ±10%	100	25	0.90	4.350	100	734.5	29	-	-
470	±2, ±5, ±10%	100	23	0.60	3.600	80	-	-	-	-

WL05 Wire Wound Chip Inductors / Standard Type

Inductance (nH)	Tolerance	L Freq. (MHz)	Quality Factor min.	SRF (GHz) min.	DCR (Ω) max.	IDC (mA) max.
2.7	±5, ±10%	250	80 @ 1500MHz	7.900	0.06	800
2.8	±5, ±10%	250	80 @ 1500MHz	7.900	0.06	800
3.0	±5, ±10%	250	65 @ 1500MHz	7.900	0.06	800
3.3	±5, ±10%	250	50 @ 1500MHz	6.000	0.08	600
3.9	±5, ±10%	250	50 @ 1500MHz	5.500	0.08	600
4.7	±5, ±10%	250	65 @ 1000MHz	5.500	0.08	600
5.6	±5, ±10%	250	65 @ 1000MHz	5.500	0.08	600
6.2	±5, ±10%	250	50 @ 1000MHz	5.500	0.11	600
6.8	±5, ±10%	250	50 @ 1000MHz	5.500	0.11	600
7.5	±5, ±10%	250	50 @ 1000MHz	4.500	0.14	600
8.2	±5, ±10%	250	50 @ 1000MHz	4.700	0.12	600
8.7	±5, ±10%	250	50 @ 1000MHz	4.000	0.21	400
10	±2, ±5, ±10%	250	60 @ 500MHz	4.200	0.10	600
12	±2, ±5, ±10%	250	50 @ 500MHz	4.000	0.15	600
15	±2, ±5, ±10%	250	50 @ 500MHz	3.400	0.17	600
18	±2, ±5, ±10%	250	50 @ 500MHz	3.300	0.20	600
20	±2, ±5, ±10%	250	55 @ 500MHz	2.600	0.22	500
22	±2, ±5, ±10%	250	55 @ 500MHz	2.600	0.22	500
24	±2, ±5, ±10%	250	50 @ 500MHz	2.000	0.22	500
27	±2, ±5, ±10%	250	55 @ 500MHz	2.500	0.25	500
30	±2, ±5, ±10%	250	60 @ 500MHz	2.050	0.25	500
33	±2, ±5, ±10%	250	60 @ 500MHz	2.050	0.27	500
36	±2, ±5, ±10%	250	55 @ 500MHz	1.700	0.27	500
39	±2, ±5, ±10%	250	60 @ 500MHz	2.000	0.29	500
43	±2, ±5, ±10%	200	60 @ 500MHz	1.650	0.34	500
47	±2, ±5, ±10%	200	60 @ 500MHz	1.650	0.31	500
56	±2, ±5, ±10%	200	60 @ 500MHz	1.550	0.34	500
68	±2, ±5, ±10%	200	60 @ 500MHz	1.450	0.38	500
72	±2, ±5, ±10%	150	65 @ 500MHz	1.400	0.40	500
82	±2, ±5, ±10%	150	65 @ 500MHz	1.300	0.42	400
91	±2, ±5, ±10%	150	65 @ 500MHz	1.200	0.48	400
100	±2, ±5, ±10%	150	65 @ 500MHz	1.200	0.46	400
110	±2, ±5, ±10%	150	50 @ 250MHz	1.000	0.48	400
120	±2, ±5, ±10%	150	50 @ 250MHz	1.100	0.51	400
150	±2, ±5, ±10%	100	50 @ 250MHz	0.920	0.56	400
160	±2, ±5, ±10%	100	50 @ 250MHz	0.870	0.60	400
180	±2, ±5, ±10%	100	50 @ 250MHz	0.870	0.64	400
200	±2, ±5, ±10%	100	50 @ 250MHz	0.860	0.66	400
220	±2, ±5, ±10%	100	50 @ 250MHz	0.850	0.70	400
240	±2, ±5, ±10%	100	44 @ 250MHz	0.690	1.00	350
250	±2, ±5, ±10%	100	50 @ 250MHz	0.680	1.00	350
270	±2, ±5, ±10%	100	48 @ 250MHz	0.650	1.00	350
300	±2, ±5, ±10%	100	48 @ 250MHz	0.620	1.20	330
330	±2, ±5, ±10%	100	48 @ 250MHz	0.600	1.40	310
360	±2, ±5, ±10%	100	48 @ 250MHz	0.580	1.45	300
390	±2, ±5, ±10%	100	48 @ 250MHz	0.560	1.50	290
430	±2, ±5, ±10%	50	33 @ 100MHz	0.430	1.70	230
470	±2, ±5, ±10%	50	33 @ 100MHz	0.375	1.70	250
560	±2, ±5, ±10%	25	23 @ 50MHz	0.340	1.90	230
600	±2, ±5, ±10%	25	23 @ 50MHz	0.260	1.60	450
620	±2, ±5, ±10%	25	23 @ 50MHz	0.220	2.20	210
680	±2, ±5, ±10%	25	23 @ 50MHz	0.200	2.20	190
750	±2, ±5, ±10%	25	23 @ 50MHz	0.200	2.30	180
820	±2, ±5, ±10%	25	23 @ 50MHz	0.200	2.35	180
1000	±2, ±5, ±10%	25	20 @ 50MHz	0.100	2.50	170

WL05 Wire Wound Chip Inductors / Standard Type

Inductance (nH)	Tolerance	L Freq. (MHz)	Quality Factor min.	SRF (GHz) min.	DCR (Ω) max.	IDC (mA) max.
1200	±2, ±5, ±10%	7.9	18 @ 25MHz	0.100	2.50	170
1500	±2, ±5, ±10%	7.9	16 @ 25MHz	0.100	2.50	170
1800	±2, ±5, ±10%	7.9	16 @ 7.9MHz	0.080	2.50	170
2200	±2, ±5, ±10%	7.9	16 @ 7.9MHz	0.060	2.70	160
2700	±2, ±5, ±10%	7.9	16 @ 7.9MHz	0.050	3.10	150
3300	±2, ±5, ±10%	7.9	15 @ 7.9MHz	0.040	4.40	90
4700	±2, ±5, ±10%	7.9	15 @ 7.9MHz	0.040	6.40	90

WL08 Wire Wound Chip Inductors / Standard Type

Inductance (nH)	Tolerance	L Freq. (MHz)	Quality Factor min.	SRF (GHz) min.	DCR (Ω) max.	IDC (mA) max.
4.7	±5, ±10%	50	50 @ 1500MHz	4.000	0.15	1000
*5.6	±5, ±10%	50	50 @ 1500MHz	4.000	0.15	1000
*10	±2, ±5, ±10%	50	50 @ 500MHz	4.100	0.08	1000
*12	±2, ±5, ±10%	50	50 @ 500MHz	3.300	0.09	1000
*15	±2, ±5, ±10%	50	50 @ 500MHz	2.500	0.11	1000
*18	±2, ±5, ±10%	50	50 @ 350MHz	2.400	0.12	1000
*22	±2, ±5, ±10%	50	55 @ 350MHz	2.400	0.12	1000
24	±2, ±5, ±10%	50	55 @ 350MHz	1.900	0.13	1000
*27	±2, ±5, ±10%	50	55 @ 350MHz	1.600	0.13	1000
30	±2%, ±5%, ±10%	50	60 @ 350MHz	1.600	0.14	1000
*33	±2, ±5, ±10%	50	60 @ 350MHz	1.600	0.14	1000
36	±2, ±5, ±10%	50	60 @ 350MHz	1.600	0.15	1000
*39	±2, ±5, ±10%	50	60 @ 350MHz	1.500	0.15	1000
*47	±2, ±5, ±10%	50	65 @ 350MHz	1.500	0.16	1000
*56	±2, ±5, ±10%	50	65 @ 350MHz	1.300	0.18	1000
*62	±2, ±5, ±10%	50	65 @ 350MHz	1.250	0.20	1000
*68	±2, ±5, ±10%	50	65 @ 350MHz	1.300	0.20	1000
75	±2, ±5, ±10%	50	60 @ 350MHz	1.100	0.21	1000
*82	±2, ±5, ±10%	50	60 @ 350MHz	1.000	0.22	1000
91	±2, ±5, ±10%	50	50 @ 350MHz	1.000	0.45	1000
*100	±2, ±5, ±10%	25	60 @ 350MHz	1.000	0.56	650
*120	±2, ±5, ±10%	25	60 @ 350MHz	0.950	0.63	650
*150	±2, ±5, ±10%	25	45 @ 100MHz	0.850	0.70	800
*180	±2, ±5, ±10%	25	45 @ 100MHz	0.750	0.77	620
*220	±2, ±5, ±10%	25	45 @ 100MHz	0.700	0.84	500
*240	±2, ±5, ±10%	25	45 @ 100MHz	0.650	0.88	500
*270	±2, ±5, ±10%	25	45 @ 100MHz	0.600	0.91	690
*300	±2, ±5, ±10%	25	45 @ 100MHz	0.585	1.00	450
*330	±2, ±5, ±10%	25	45 @ 100MHz	0.570	1.05	450
*360	±2, ±5, ±10%	25	45 @ 100MHz	0.530	1.10	470
*390	±2, ±5, ±10%	25	45 @ 100MHz	0.500	1.12	630
*430	±2, ±5, ±10%	25	45 @ 100MHz	0.480	1.15	470
*470	±2, ±5, ±10%	25	45 @ 100MHz	0.450	1.19	470
*560	±2, ±5, ±10%	25	45 @ 100MHz	0.415	1.33	580
*620	±2, ±5, ±10%	25	45 @ 100MHz	0.375	1.40	300
*680	±2, ±5, ±10%	25	45 @ 100MHz	0.375	1.47	540
*750	±2, ±5, ±10%	25	45 @ 100MHz	0.360	1.54	360
*820	±2, ±5, ±10%	25	45 @ 100MHz	0.350	1.61	400
*910	±2, ±5, ±10%	25	35 @ 50MHz	0.320	1.68	380
*1000	±2, ±5, ±10%	25	35 @ 50MHz	0.290	1.75	370
*1200	±2, ±5, ±10%	7.9	35 @ 50MHz	0.250	2.00	310

SMD Wire Wound Chip Inductor

WL08 Wire Wound Chip Inductors / Standard Type

Inductance (nH)	Tolerance	L Freq. (MHz)	Quality Factor min.	SRF (GHz) min.	DCR (Ω) max.	IDC (mA) max.
*1500	±2, ±5, ±10%	7.9	28 @ 50MHz	0.200	2.30	330
*1800	±2, ±5, ±10%	7.9	28 @ 50MHz	0.160	2.60	300
*2200	±2, ±5, ±10%	7.9	28 @ 50MHz	0.160	2.80	280
*2700	±2, ±5, ±10%	7.9	22 @ 25MHz	0.140	3.20	290
*3300	±2, ±5, ±10%	7.9	22 @ 25MHz	0.110	3.40	290
*3900	±2, ±5, ±10%	7.9	18 @ 25MHz	0.100	3.60	260
*4700	±2, ±5, ±10%	7.9	18 @ 25MHz	0.090	4.00	260
5600	±2, ±5, ±10%	7.9	16 @ 7.96MHz	0.020	4.00	240
6800	±2, ±5, ±10%	7.9	15 @ 7.96MHz	0.040	4.90	200
8200	±2, ±5, ±10%	7.9	15 @ 7.96MHz	0.025	6.00	170
10000	±2, ±5, ±10%	2.52	15 @ 7.96MHz	0.020	9.00	150
12000	±2, ±5, ±10%	2.52	15 @ 7.96MHz	0.018	10.5	130
15000	±2, ±5, ±10%	2.52	15 @ 7.96MHz	0.015	11.5	120

" * " Test Methods / Instrument: Network / Spectrum Analyzer

WL08(S) Wire Wound Chip Inductors / Standard Type

Inductance (nH)	Tolerance	L Freq. (MHz)	Quality Factor min.	SRF (GHz) min.	DCR (Ω) max.	IDC (mA) max.
10	±2, ±5, ±10%	50	50 @ 500MHz	4.100	0.08	1000
12	±2, ±5, ±10%	50	50 @ 500MHz	3.300	0.09	1000
18	±2, ±5, ±10%	50	50 @ 350MHz	2.400	0.12	1000
22	±2, ±5, ±10%	50	55 @ 350MHz	2.400	0.12	1000
27	±2, ±5, ±10%	50	55 @ 350MHz	1.600	0.13	1000
33	±2, ±5, ±10%	50	60 @ 350MHz	1.600	0.14	1000
39	±2, ±5, ±10%	50	60 @ 350MHz	1.500	0.15	1000
47	±2, ±5, ±10%	50	65 @ 350MHz	1.500	0.16	1000
56	±2, ±5, ±10%	50	65 @ 350MHz	1.300	0.18	1000
62	±2, ±5, ±10%	50	65 @ 350MHz	1.250	0.20	1000
68	±2, ±5, ±10%	50	65 @ 350MHz	1.300	0.20	1000
82	±2, ±5, ±10%	50	60 @ 350MHz	1.000	0.22	1000
100	±2, ±5, ±10%	25	60 @ 350MHz	1.000	0.56	650
120	±2, ±5, ±10%	25	60 @ 350MHz	0.950	0.63	650
150	±2, ±5, ±10%	25	45 @ 100MHz	0.850	0.70	800
180	±2, ±5, ±10%	25	45 @ 100MHz	0.750	0.77	620
220	±2, ±5, ±10%	25	45 @ 100MHz	0.700	0.84	500
240	±2, ±5, ±10%	25	45 @ 100MHz	0.650	0.88	500
270	±2, ±5, ±10%	25	45 @ 100MHz	0.600	0.91	690
300	±2, ±5, ±10%	25	45 @ 100MHz	0.585	1.00	450
330	±2, ±5, ±10%	25	45 @ 100MHz	0.570	1.05	450
360	±2, ±5, ±10%	25	45 @ 100MHz	0.530	1.10	470
390	±2, ±5, ±10%	25	45 @ 100MHz	0.500	1.12	630
430	±2, ±5, ±10%	25	45 @ 100MHz	0.480	1.15	470
470	±2, ±5, ±10%	25	45 @ 100MHz	0.450	1.19	470
560	±2, ±5, ±10%	25	45 @ 100MHz	0.415	1.33	580
620	±2, ±5, ±10%	25	45 @ 100MHz	0.375	1.40	300
680	±2, ±5, ±10%	25	45 @ 100MHz	0.375	1.47	540
750	±2, ±5, ±10%	25	45 @ 100MHz	0.360	1.54	360
820	±2, ±5, ±10%	25	45 @ 100MHz	0.350	1.61	400
1000	±2, ±5, ±10%	25	35 @ 50MHz	0.290	1.75	370
1200	±2, ±5, ±10%	7.9	35 @ 50MHz	0.250	2.00	310
1800	±2, ±5, ±10%	7.9	28 @ 50MHz	0.160	2.60	300
2200	±2, ±5, ±10%	7.9	28 @ 50MHz	0.160	2.80	280

WL06 Wire Wound Chip Inductors / Standard Type

Inductance (nH)	Tolerance	L Freq. (MHz)	Quality Factor min.	SRF (GHz) min.	DCR (Ω) max.	IDC (mA) max.
6.8	±5, ±10%	100	30 @ 300MHz	5.50	0.07	1000
10	±5, ±10%	100	40 @ 300MHz	4.00	0.08	1000
12	±5, ±10%	100	40 @ 300MHz	3.20	0.08	1000
15	±5, ±10%	100	40 @ 300MHz	3.20	0.10	1000
18	±5, ±10%	100	50 @ 300MHz	2.80	0.10	1000
22	±5, ±10%	100	50 @ 300MHz	2.20	0.10	1000
24	±5, ±10%	100	50 @ 300MHz	2.00	0.10	1000
27	±2, ±5, ±10%	100	50 @ 300MHz	1.80	0.11	1000
33	±2, ±5, ±10%	100	55 @ 300MHz	1.80	0.11	1000
39	±2, ±5, ±10%	100	55 @ 300MHz	1.80	0.12	1000
47	±2, ±5, ±10%	100	55 @ 300MHz	1.50	0.13	1000
56	±2, ±5, ±10%	100	55 @ 300MHz	1.45	0.14	1000
62	±2, ±5, ±10%	100	55 @ 300MHz	1.20	0.20	1000
68	±2, ±5, ±10%	100	55 @ 300MHz	1.20	0.26	950
82	±2, ±5, ±10%	100	55 @ 300MHz	1.20	0.21	920
91	±2, ±5, ±10%	100	55 @ 300MHz	1.10	0.24	900
100	±2, ±5, ±10%	100	55 @ 300MHz	1.10	0.26	850
120	±2, ±5, ±10%	100	55 @ 300MHz	0.75	0.26	800
150	±2, ±5, ±10%	100	60 @ 300MHz	0.95	0.31	750
180	±2, ±5, ±10%	50	55 @ 300MHz	0.90	0.43	700
220	±2, ±5, ±10%	50	55 @ 300MHz	0.76	0.50	670
270	±2, ±5, ±10%	50	55 @ 300MHz	0.74	0.56	630
300	±2, ±5, ±10%	50	50 @ 150MHz	0.68	0.60	600
330	±2, ±5, ±10%	50	45 @ 150MHz	0.65	0.62	590
360	±2, ±5, ±10%	50	45 @ 150MHz	0.60	0.65	550
390	±2, ±5, ±10%	50	45 @ 150MHz	0.60	0.75	530
470	±2, ±5, ±10%	50	45 @ 150MHz	0.55	1.30	490
560	±2, ±5, ±10%	35	45 @ 150MHz	0.47	1.34	460
620	±2, ±5, ±10%	35	45 @ 150MHz	0.47	1.58	460
680	±2, ±5, ±10%	35	45 @ 150MHz	0.45	1.58	430
750	±2, ±5, ±10%	35	45 @ 150MHz	0.44	2.25	320
820	±2, ±5, ±10%	35	45 @ 150MHz	0.42	1.82	400
910	±2, ±5, ±10%	35	45 @ 150MHz	0.41	2.95	310
1000	±2, ±5, ±10%	35	45 @ 150MHz	0.40	2.80	320
1200	±2, ±5, ±10%	35	45 @ 150MHz	0.38	3.20	300

High Current Electrical Specifications

WL03(H) Wire Wound Chip Inductors / High Current Type

Inductance (nH)	Tolerance	L Freq. (MHz)	Quality Factor min.	SRF (GHz) min.	DCR (Ω) max.	IDC (mA) max.
1.6	±5, ±10%	250	24	12.50	0.030	2400
3.6	±5, ±10%	250	24	5.90	0.048	2300
3.9	±5, ±10%	250	25	5.90	0.054	2200
6.8	±5, ±10%	250	35	5.80	0.054	2100
7.5	±5, ±10%	250	38	3.70	0.059	2100
8.2	±5, ±10%	250	38	3.70	0.060	2000
10	±2, ±5, ±10%	250	38	3.70	0.071	2000
12	±2, ±5, ±10%	250	38	3.00	0.075	2000
15	±2, ±5, ±10%	250	38	2.80	0.080	1900
18	±2, ±5, ±10%	250	40	2.80	0.099	1900
22	±2, ±5, ±10%	250	42	2.40	0.099	1800
24	±2, ±5, ±10%	250	42	2.40	0.105	1800

High Q Electrical Specifications

WL02(H) Wire Wound Chip Inductors /High Q Type

Inductance (nH)	Tolerance	L Freq. (MHz)	Quality Factor		SRF (GHz) min.	DCR (Ω) max.	IDC (mA) max.
			900MHz	1.7GHz			
1.0	±0.2nH, ±0.5nH, ±5%, ±10%	250	46	75	16.0	0.030	2300
2.0	±0.2nH, ±0.5nH, ±5%, ±10%	250	58	85	15.2	0.038	2100
2.2	±0.2nH, ±0.5nH, ±5%, ±10%	250	60	86	15.1	0.038	2100
2.4	±0.2nH, ±0.5nH, ±5%, ±10%	250	60	83	14.0	0.042	2000
2.7	±0.2nH, ±0.5nH, ±5%, ±10%	250	62	85	13.0	0.075	1500
3.3	±0.2nH, ±0.5nH, ±5%, ±10%	250	66	95	12.8	0.045	1700
3.6	±0.2nH, ±0.5nH, ±5%, ±10%	250	65	94	11.7	0.045	1700
3.9	±0.2nH, ±0.5nH, ±5%, ±10%	250	64	98	9.50	0.045	1700
4.3	±0.5nH, ±5%, ±10%	250	63	90	7.15	0.050	1600
4.7	±0.5nH, ±5%, ±10%	250	58	83	6.85	0.070	1500
5.1	±2%, ±5%, ±10%	250	54	76	6.80	0.115	1200
5.6	±2%, ±5%, ±10%	250	73	105	6.50	0.050	1600
6.2	±2%, ±5%, ±10%	250	73	100	5.80	0.055	1600
6.8	±2%, ±5%, ±10%	250	68	94	5.80	0.065	1500
7.5	±2%, ±5%, ±10%	250	60	82	5.40	0.090	1400
8.2	±2%, ±5%, ±10%	250	68	95	5.40	0.065	1500
8.7	±2%, ±5%, ±10%	250	68	95	5.00	0.065	1500
9.0	±2%, ±5%, ±10%	250	67	92	5.00	0.080	1400
9.5	±2%, ±5%, ±10%	250	64	90	4.70	0.090	1400
10	±2%, ±5%, ±10%	250	62	90	4.70	0.100	1300
11	±2%, ±5%, ±10%	250	68	98	4.70	0.065	1400
12	±2%, ±5%, ±10%	250	66	100	4.40	0.100	1200
13	±2%, ±5%, ±10%	250	62	82	4.20	0.150	870
15	±2%, ±5%, ±10%	250	62	85	3.90	0.110	1100
16	±2%, ±5%, ±10%	250	57	77	3.70	0.140	850
18	±2%, ±5%, ±10%	250	58	74	3.55	0.120	900
19	±2%, ±5%, ±10%	250	61	88	3.50	0.145	850
20	±2%, ±5%, ±10%	250	58	76	3.50	0.185	780
21	±2%, ±5%, ±10%	250	48	62	1.70	0.460	450
22	±2%, ±5%, ±10%	250	60	74	3.30	0.160	800
23	±2%, ±5%, ±10%	250	60	77	3.30	0.160	800
24	±2%, ±5%, ±10%	250	55	71	3.15	0.200	700
25	±2%, ±5%, ±10%	250	57	73	3.15	0.250	600
26	±2%, ±5%, ±10%	250	56	74	3.15	0.285	450
27	±2%, ±5%, ±10%	250	62	86	3.20	0.320	450
30	±2%, ±5%, ±10%	250	61	87	2.90	0.330	450
33	±2%, ±5%, ±10%	250	61	80	2.80	0.330	490
36	±2%, ±5%, ±10%	250	59	76	2.80	0.380	480
37	±2%, ±5%, ±10%	250	57	72	2.70	0.460	470
39	±2%, ±5%, ±10%	250	56	84	2.60	0.430	450
40	±2%, ±5%, ±10%	250	56	75	2.60	0.430	450
43	±2%, ±5%, ±10%	250	52	68	2.50	0.520	450
47	±2%, ±5%, ±10%	250	48	62	2.40	0.580	420
51	±2%, ±5%, ±10%	250	52	59	2.30	0.700	360

[WL03\(Q\) Wire Wound Chip Inductors / High Q Type](#)

Inductance (nH)	Tolerance	L Freq. (MHz)	Q typ at 250(MHz)	SRF typ (GHz)	DCR (Ω) max.	IDC (mA) max.	900MHz		1.7GHz	
							L typ	Q typ	L Typ	Q Typ
1.8	±5, ±10%	250	23	16.0	0.033	2100	1.77	40	1.77	65
2.2	±5, ±10%	250	13	15.0	0.180	900	2.14	25	2.12	35
3.3	±5, ±10%	250	32	9.60	0.024	1900	3.28	67	3.32	104
3.6	±2, ±5, ±10%	250	40	9.70	0.031	1900	3.59	70	3.62	116
3.9	±2, ±5, ±10%	250	35	7.50	0.039	1600	3.88	68	3.95	108
4.3	±2, ±5, ±10%	250	30	7.50	0.080	1300	4.29	58	4.31	91
4.7	±2, ±5, ±10%	250	26	7.90	0.100	1100	4.65	48	4.71	75
5.1	±2, ±5, ±10%	250	40	8.90	0.036	1700	5.08	84	5.12	140
5.6	±2, ±5, ±10%	250	48	6.60	0.036	1700	5.6	87	5.73	456
6	±2, ±5, ±10%	250	49	6.00	0.036	1700	5.92	94	6.12	154
6.8	±2, ±5, ±10%	250	42	5.80	0.042	1400	6.83	88	7.05	143
7.2	±2, ±5, ±10%	250	48	5.40	0.052	1400	7.25	96	7.38	139
7.5	±2, ±5, ±10%	250	41	5.30	0.080	1300	7.55	81	7.85	12
8.2	±2, ±5, ±10%	250	46	5.90	0.054	1400	8.21	96	8.39	148
8.7	±2, ±5, ±10%	250	46	5.50	0.054	1400	8.73	97	9.00	149
9.1	±2, ±5, ±10%	250	40	5.10	0.037	1400	9.18	76	9.64	109
9.5	±2, ±5, ±10%	250	49	4.90	0.053	1400	9.56	98	9.99	149
10	±2, ±5, ±10%	250	49	4.30	0.048	1400	10.16	90	10.64	142
11	±2, ±5, ±10%	250	41	4.10	0.058	1400	11.06	78	11.82	108
12	±2, ±5, ±10%	250	37	4.10	0.088	1100	12.26	69	13.2	91
15	±2, ±5, ±10%	250	48	3.60	0.078	1200	15.41	83	17.2	124
16	±2, ±5, ±10%	250	45	3.50	0.085	1100	16.37	77	18.7	116
18	±2, ±5, ±10%	250	41	3.30	0.066	1200	18.56	76	20.9	100
22	±2, ±5, ±10%	250	44	3.15	0.140	850	22.7	77	25.9	88
23	±2, ±5, ±10%	250	40	3.00	0.183	850	24	69	29.53	80
24	±2, ±5, ±10%	250	42	2.95	0.074	1100	24.9	77	28.9	91
27	±2, ±5, ±10%	250	44	2.80	0.150	780	28.4	74	34.0	84
30	±2, ±5, ±10%	250	49	2.80	0.130	920	31.5	82	37.9	82
33	±2, ±5, ±10%	250	45	2.70	0.170	680	34.9	76	42.9	80
36	±2, ±5, ±10%	250	44	2.50	0.225	720	38.5	69	50.0	64
39	±2, ±5, ±10%	250	48	2.45	0.19	680	41.5	78	51.9	74
43	±2, ±5, ±10%	250	45	2.45	0.17	810	45.7	83	58.1	76
47	±2, ±5, ±10%	200	47	2.30	0.24	680	50.6	77	66.9	72
51	±2, ±5, ±10%	200	49	2.30	0.28	660	54.6	73	71.3	62
56	±2, ±5, ±10%	200	50	2.20	0.30	610	60.3	74	79.9	56
68	±2, ±5, ±10%	200	46	2.00	0.33	600	75.5	73	113.3	49
72	±2, ±5, ±10%	150	46	1.90	0.42	550	80.8	69	-	-
75	±2, ±5, ±10%	150	46	1.90	0.52	500	84.6	71	-	-
82	±2, ±5, ±10%	150	45	1.80	0.46	510	94	62	-	-
91	±2, ±5, ±10%	150	45	1.65	0.58	440	103	64	-	-
100	±2, ±5, ±10%	150	49	1.70	0.54	470	114	69	-	-
110	±2, ±5, ±10%	150	47	1.60	0.58	440	126.2	63	-	-
120	±2, ±5, ±10%	150	47	1.55	0.72	420	142.4	61	-	-
150	±2, ±5, ±10%	150	47	1.35	0.82	390	188.8	57	-	-
180	±2, ±5, ±10%	100	48	1.30	1.50	310	232.2	50	-	-
200	±2, ±5, ±10%	100	47	1.25	2.00	280	265	47	-	-
210	±2, ±5, ±10%	100	48	1.20	2.00	280	288	45	-	-
220	±2, ±5, ±10%	100	47	1.10	2.00	280	315	41	-	-
250	±2, ±5, ±10%	100	45	1.05	3.00	240	-	-	-	-
270	±2, ±5, ±10%	100	46	1.05	2.25	260	-	-	-	-
300	±2, ±5, ±10%	100	47	0.99	2.80	220	-	-	-	-
330	±2, ±5, ±10%	100	46	0.93	3.60	180	-	-	-	-
360	±2, ±5, ±10%	100	47	0.93	4.00	170	-	-	-	-
390	±2, ±5, ±10%	100	47	0.88	4.00	170	-	-	-	-

WL05(H) Wire Wound Chip Inductors / **High Q Type**

Inductance (nH)	Tolerance	L Freq. (MHz)	Quality Factor min.	SRF (GHz) min.	DCR (Ω) max.	IDC (mA) max.
2.5	±5, ±10%	250	80 @ 1500MHz	6.00	0.020	1600
5.6	±5, ±10%	250	98 @ 1500MHz	6.00	0.035	1600
6.2	±5, ±10%	250	88 @ 1000MHz	4.75	0.035	1600
6.8	±5, ±10%	250	80 @ 1000MHz	4.40	0.035	1600
8.2	±5, ±10%	250	75 @ 1000MHz	3.00	0.075	1000
10	±5, ±10%	250	80 @ 1000MHz	3.00	0.060	1600
12	±5, ±10%	250	80 @ 1000MHz	3.00	0.045	1600
15	±2, ±5, ±10%	250	80 @ 1000MHz	2.80	0.100	1200
16	±2, ±5, ±10%	250	72 @ 500MHz	2.95	0.060	1500
18	±2, ±5, ±10%	250	75 @ 500MHz	2.55	0.060	1400
20	±2, ±5, ±10%	250	70 @ 500MHz	2.05	0.055	1400
22	±2, ±5, ±10%	250	80 @ 500MHz	2.00	0.100	1200
27	±2, ±5, ±10%	250	75 @ 500MHz	2.00	0.070	1300
30	±2, ±5, ±10%	250	65 @ 500MHz	1.95	0.095	1200
39	±2, ±5, ±10%	250	65 @ 500MHz	1.60	0.110	1100
48	±2, ±5, ±10%	200	65 @ 500MHz	1.40	0.095	1200
51	±2, ±5, ±10%	200	65 @ 500MHz	1.40	0.120	1000

WL08(H) Wire Wound Chip Inductors / **High Q Type**

Inductance (nH)	Tolerance	L Freq. (MHz)	Quality Factor min.	SRF (GHz) min.	DCR (Ω) max.	IDC (mA) max.
3.0	±5, ±10%	50	70 @ 1500MHz	6.00	0.04	1600
3.9	±5, ±10%	50	75 @ 1500MHz	6.00	0.05	1600
4.1	±5, ±10%	50	75 @ 1500MHz	6.00	0.05	1600
7.8	±5, ±10%	50	75 @ 500MHz	3.80	0.05	1600
10	±2, ±5, ±10%	50	60 @ 500MHz	3.60	0.06	1600
12	±2, ±5, ±10%	50	70 @ 500MHz	2.80	0.06	1500
18	±2, ±5, ±10%	50	62 @ 350MHz	2.70	0.07	1400
22	±2, ±5, ±10%	50	62 @ 350MHz	2.05	0.07	1400
33	±2, ±5, ±10%	50	75 @ 350MHz	1.70	0.09	1300
39	±2, ±5, ±10%	50	75 @ 350MHz	1.30	0.09	1300
47	±2, ±5, ±10%	50	75 @ 350MHz	1.45	0.12	1200
56	±2, ±5, ±10%	50	75 @ 350MHz	1.23	0.12	1200
68	±2, ±5, ±10%	50	80 @ 350MHz	1.15	0.13	1100
82	±2, ±5, ±10%	50	80 @ 350MHz	1.06	0.16	1100
100	±2, ±5, ±10%	50	50 @ 350MHz	0.82	0.16	1000

■ Parts (3.0nH, 7.8nH) are wound on a low profile bobbin. (Max 2.41×2.01×1.09)

■ Soldering Condition

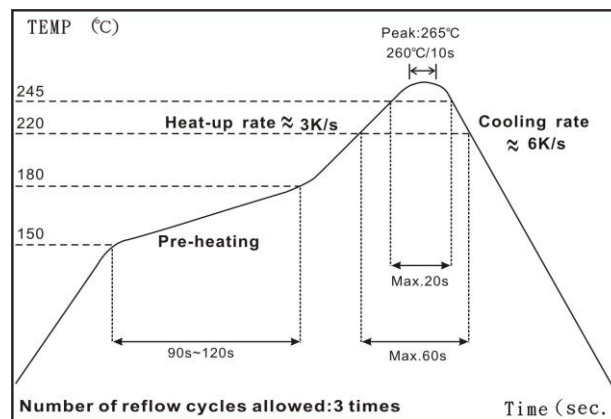

IR Reflow Soldering

(1) Time of IR reflow soldering at maximum temperature point 260°C : 10s

Environmental Characteristics

Electrical Performance Test

Item	Requirement	Test Method
Inductance	Refer to standard electrical characteristic spec.	HP4286/E4982A
Q		HP4286/E4982A
SRF		HP4287/E4982A
DC Resistance RDC		Micro-Ohm meter (Gom-801G)/E4982A
Rated Current IDC		Applied the current to coils, the temperature of coil increases $\Delta T15^{\circ}\text{C}$ ($T_a=25^{\circ}\text{C}$).
Over Load	Inductors shall have no evidence of electrical and mechanical damage	Applied 2 times of rated allowed DC current to inductor for a period of 5 minutes
Withstanding Voltage	Inductors shall be no evidence of electrical and mechanical damage.	AC voltage of 500 VAC applied between inductors terminal and case for 1 min.
Insulation Resistance	1000M ohm min.	100 V _{DC} applied between inductor terminal and case

Mechanical Performance Test

Item	Requirement	Test Method
Vibration	Appearance: No damage L change: within $\pm 5\%$ Q change: within $\pm 10\%$	Test device shall be soldered on the substrate Oscillation Frequency: 10 to 55 to 10Hz for 1 min. Amplitude: 1.5 mm Time: 2 hrs for each axis (X, Y & Z), total 6 hrs
Resistance to Soldering Heat		Solder Temperature: $260\pm 5^{\circ}\text{C}$ Immersion Time: 10 ± 2 seconds
Component Adhesion (Push Test)	1 lbs. For 0402 2 lbs. For 0603 3 lbs. For the rest	The device should be soldered (260 ± 5 for 10 seconds) to a tinned copper subs rate. A dynamiter force gauge should be applied to the side of the component. The device must with stand a minimum force of 2 or 4 pounds without a failure of adhesion on termination
Drop	No damage	Dropping chip by each side and each corner. Drop 10 times in total Drop height: 100 cm Drop weight: 125 g
Solderability	90% covered with solder	Inductor shall be dipped in a melted solder bath at 245 ± 5 for 3 seconds
Resistance to Solvent	No damage on appearance and marking	MIL-STD-202, Method 215

Climatic Test

Item	Requirement	Item															
Temperature Characteristic	Appearance: No damage L change: within $\pm 10\%$ Q change: within $\pm 20\%$	-40~+125°C															
Humidity		Temperature: $40\pm 2^{\circ}\text{C}$ Relative Humidity: 90~95% Time: 96 ± 2 hrs Measured after exposure in the room condition for 2 hrs															
Low Temperature Storage		Temperature: $-40\pm 2^{\circ}\text{C}$ Time: 96 ± 2 hrs Inductors are tested after 1 hour at room temperature															
Thermal Shock		One cycle: <table border="1" style="width: 100%;"> <thead> <tr> <th>Step</th> <th>Temperature ($^{\circ}\text{C}$)</th> <th>Time (min.)</th> </tr> </thead> <tbody> <tr> <td>1</td> <td>-25 ± 3</td> <td>30</td> </tr> <tr> <td>2</td> <td>25 ± 2</td> <td>15</td> </tr> <tr> <td>3</td> <td>125 ± 3</td> <td>30</td> </tr> <tr> <td>4</td> <td>25 ± 2</td> <td>15</td> </tr> </tbody> </table> Total: 5 cycles	Step	Temperature ($^{\circ}\text{C}$)	Time (min.)	1	-25 ± 3	30	2	25 ± 2	15	3	125 ± 3	30	4	25 ± 2	15
Step		Temperature ($^{\circ}\text{C}$)	Time (min.)														
1		-25 ± 3	30														
2		25 ± 2	15														
3		125 ± 3	30														
4	25 ± 2	15															
High Temperature Storage	Temperature: $125\pm 2^{\circ}\text{C}$ Time: 96 ± 2 hrs Measured after exposure in the room condition for 1hour																
High Temperature Load Life	Temperature: $85\pm 2^{\circ}\text{C}$ Time: 1000 ± 12 hrs Load: Allowed DC current																
Damp Heat with Load	Temperature: $40\pm 2^{\circ}\text{C}$ Relative Humidity: 90~95% Time: 1000 ± 12 hrs Load: Allowed DC current																

Storage Temperature: 15~28°C; Humidity < 80%RH

■ Packaging

Reel Dimensions & Packaging Quantity

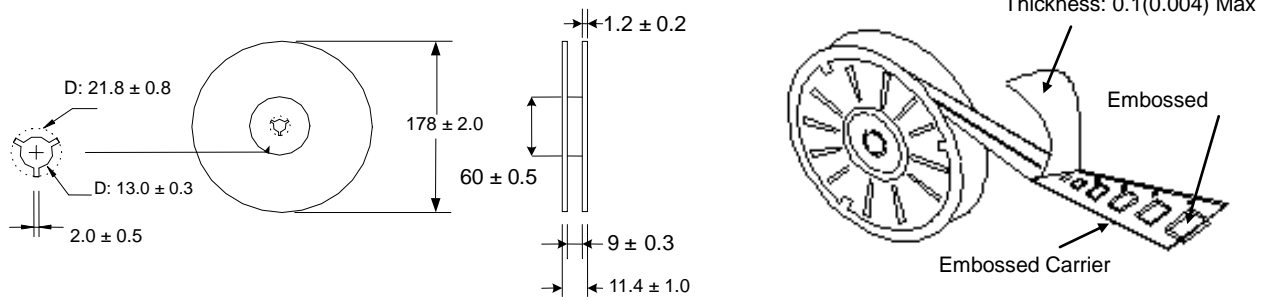

Paper Tape specification and Packaging Quantity

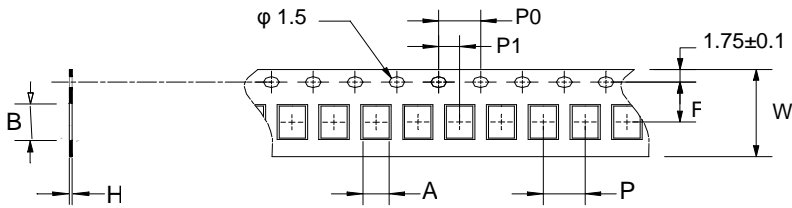

Unit: mm

Type	A	B	H	F	P	P ₀	P ₁	W	Reel (EA)
WL02	0.81	1.23	0.73	3.50	2.00	4.00	2.00	8.00	4,000
WL03	1.35	1.95	0.95	3.50	4.00	4.00	2.00	8.00	4,000

Embossed Plastic Tape specification and Packaging Quantity

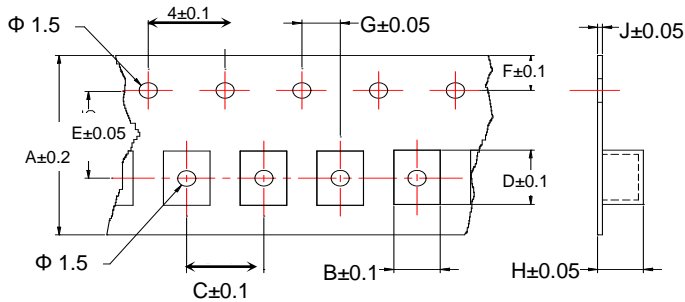

Unit: mm

Type	A	B	C	D	E	F	G	H	J	Reel (EA)
WL05	8	1.85	4	2.30	3.5	1.75	2	1.45	0.23	2,000
WL05 (H)	8	1.85	4	2.30	3.5	1.75	2	1.45	0.23	2,000
WL06	8	1.95	4	3.50	3.5	1.75	2	1.50	0.23	2,000
WL08	8	2.70	4	2.80	3.5	1.75	2	2.00	0.23	2,000
WL08 (H)	8	2.70	4	2.80	3.5	1.75	2	2.00	0.23	2,000

REVISION HISTORY

REVISION	DATE	CHANGE NOTIFICATION	DESCRIPTION
Version C2	July 31,2014	-	- Revises WL05 C size 1.52 -- >1.6
Version C3	Nov 07,2014	-	- Increase WL08 (S) and WL02 (H) specification content
Version C4	Apr 30, 2015	-	- Standard Electrical Specifications updated
Version C5	Jul 15, 2016	-	- Increase WL03 (Q) specification content - Remove Material Description - Features increase AEC-Q200 Compliance (Standard Type) - Modify Storage Temperature - Increase Soldering Condition
Version C6	Dec 23, 2016	-	- Revises WL05 C size 1.6 -- >1.52
Version C7	Jul 10, 2018	-	- Revises WL06 Dimensions specification A size 3.45 -- >3.56, B size 1.90 -- >2.16 C size 1.40 -- >1.52, D&F size 0.50 -- >0.51 E size 1.60 -- >1.62, J size 1.78 -- >1.80
Version C8	Nov 01, 2018	PCN-180801	- Delete 0603/ 0805/ 1008 Color Code