

BWLS Series



BWLS Series is the newest in open type ferrite wire wound chip inductors. The wire wound ferrite construction supports higher SRF, lower DCR and superior Q values than other ferrite chip inductors.

Features

- RoHS compliant
- Very strong solderability by reflow soldering and soldering iron
- Highly accurate dimensions
- Can be mounted automatically
- Terminals are highly resistant to external forces
- Highly resistant to mechanical shocks and pressure
- Highly reliable in environments of sudden temperature change and humidity
- Low DCR & better Q value in ferrite series

Applications

- Telecom and datacom applications such as xDSL
- Cable modem
- Set-top box
- CATV filter/tuner
- Wireless LAN, etc

Product Identification

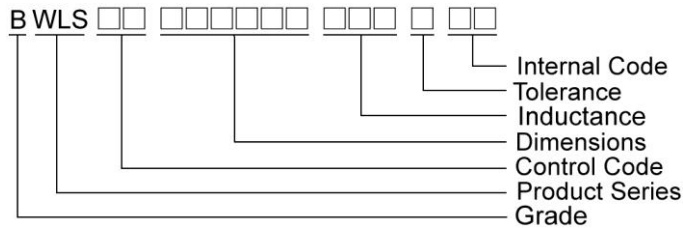

Shape and Dimensions / Recommended Pattern

BWLS00060404

BWLS00100606/161109/241715/302522

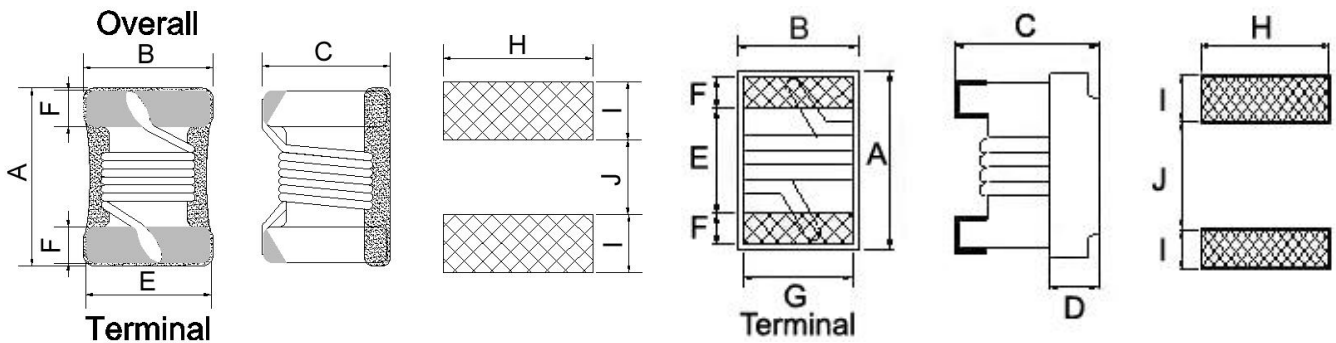

Dimensions in mm

TYPE	A Max	B Max	C Max	D	E	F	G	H	I	J
BWLS00060404	0.58	0.46	0.45	-	0.38	0.12	-	0.46	0.18	0.22
BWLS00100606	1.02±0.1	0.55±0.1	0.56±0.1	0.25	0.54	0.23	0.50	0.65	0.38	0.44
BWLS00161109	1.6 ^{+0.2} _{-0.1}	1.1±0.1	0.9 ^{+0.2} _{-0.1}	0.38	0.86	0.33	0.76	1.02	0.64	0.64
BWLS00241715	2.4	1.72	1.52	0.70	1.02	0.50	1.27	1.78	1.02	0.76
BWLS00302522	2.99	2.50	2.20	0.70	1.52	0.51	2.03	2.54	1.02	1.27

SMD Wire Wound Ferrite Chip Inductors – BWLS Series

Electrical Characteristics

Part Number	Inductance (nH)	Tolerance (±%)	Test Frequency (MHz)	Q Typ.	SRF (MHz)Min.	RDC (Ω)Max.	Irms (mA)Typ.
BWLS000604042N2□00	2.2	10	100	5	3000	0.09	1600
BWLS000604046N8□00	6.8	10 / 5	100	6	2400	0.11	950
BWLS000604047N8□00	7.8	10 / 5	100	7	2500	0.11	1050
BWLS0006040415N□00	15	10 / 5	100	7	2300	0.12	750
BWLS0006040417N□00	17	10 / 5	100	7	2400	0.13	750
BWLS0006040426N□00	26	10 / 5	100	7	2200	0.20	750
BWLS0006040428N□00	28	10 / 5	100	7	2400	0.2.	700
BWLS0006040439N□00	39	10 / 5	100	7	2300	0.24	580
BWLS0006040443N□00	43	10 / 5	100	7	2200	0.24	600
BWLS0006040456N□00	56	10 / 5	100	7	2200	0.26	550
BWLS0006040459N□00	59	10 / 5	100	7	2200	0.26	500
BWLS0006040476N□00	76	10 / 5	100	7	2000	0.30	500
BWLS0006040478N□00	78	10 / 5	100	7	2000	0.30	500
BWLS00060404R10□00	100	10 / 5	100	7	1500	0.41	430
BWLS00060404R13□00	130	10 / 5	100	7	1500	0.44	400
BWLS00060404R16□00	160	10 / 5	100	7	1400	0.71	350
BWLS00060404R20□00	200	10 / 5	50	9	1400	0.95	260

Note: When ordering, please specify tolerance code. Tolerance : J=±5% , K=±10%

- Operating temperature range - 25°C ~ 105°C(Including self - temperature rise)
- Irms for a 15°C temperature rise from 25°C ambient with current
- Measure Equipment :
L & Q : Agilent E4991A+Agilent HP16197A
SRF : Agilent E4991A
RDC : HP4287
Irms : HP4284A+HP42841A

Test Instruments : Agilent E4991A Material/Impedance Analyzer

Typical L vs. Frequency

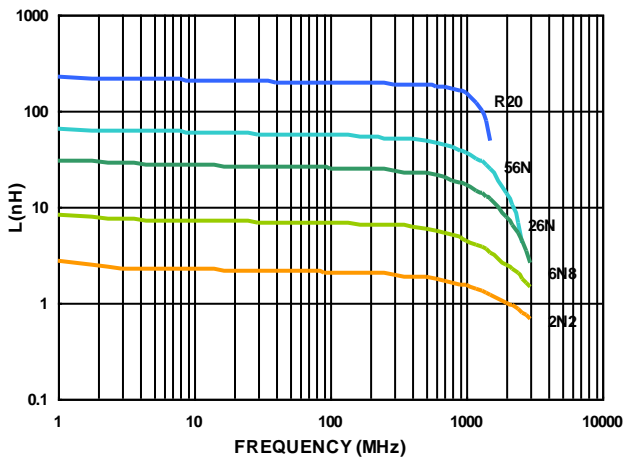

Typical Q vs. Frequency

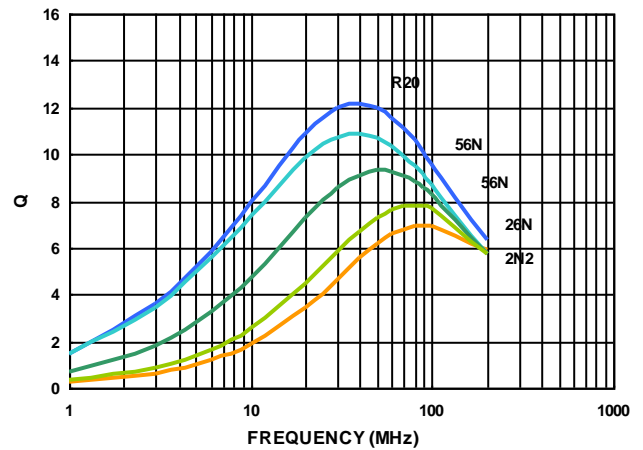

SMD Wire Wound Ferrite Chip Inductors – BWLS Series

Electrical Characteristics

Part Number	Inductance (uH)	Tolerance (±%)	Test Frequency (MHz)	Q Typ.	SRF (MHz)Typ.	RDC (Ω) Max	Irms (mA)Typ.
BWLS0010060618N□00	0.018	10 / 5	100	10	2600	0.055	1600
BWLS0010060620N□00	0.020	10 / 5	100	10	2600	0.050	1600
BWLS0010060622N□00	0.022	10	100	10	2500	0.072	1300
BWLS0010060633N□00	0.033	10 / 5	100	10	2300	0.060	1400
BWLS0010060636N□00	0.036	10 / 5	100	10	2300	0.092	1000
BWLS0010060639N□00	0.039	10 / 5	100	10	2200	0.150	830
BWLS0010060651N□00	0.051	10	100	10	1930	0.070	1100
BWLS0010060656N□00	0.056	10	100	10	1900	0.125	900
BWLS0010060672N□00	0.072	10 / 5	100	10	1650	0.100	900
BWLS0010060678N□00	0.078	10 / 5	100	10	1600	0.190	850
BWLS00100606R10□00	0.10	10	100	9	1400	0.160	900
BWLS00100606R14□00	0.14	10 / 5	50	11	1220	0.260	540
BWLS00100606R18□00	0.18	10	50	11	1150	0.330	560
BWLS00100606R20□00	0.20	10 / 5	50	11	1000	0.440	400
BWLS00100606R22□00	0.22	10 / 5	50	11	1150	0.530	380
BWLS00100606R25□00	0.25	10 / 5	25	11	900	0.360	520
BWLS00100606R27□00	0.27	10	25	11	860	0.550	360
BWLS00100606R30□00	0.30	10 / 5	25	11	860	0.410	420
BWLS00100606R33□00	0.33	10 / 5	7.9	11	820	0.680	350
BWLS00100606R36□00	0.36	10 / 5	7.9	11	810	0.575	360
BWLS00100606R39□00	0.39	10 / 5	7.9	11	760	0.890	300
BWLS00100606R42□00	0.42	10 / 5	7.9	11	700	1.100	340
BWLS00100606R47□00	0.47	10	7.9	11	650	0.730	310
BWLS00100606R56□00	0.56	10 / 5	7.9	11	600	1.100	200

Note: When ordering, please specify tolerance code. Tolerance : J=±5% , K=±10%

- Operating temperature range - 25°C ~ 105°C(Including self - temperature rise)
- I rms for a 15°C temperature rise from 25°C ambient with current
- Measure Equipment :
 L & Q : Agilent E4991A+Agilent HP16197A
 SRF : Agilent E4991A
 RDC : Chroma 16502
 I rms : HP4284A+HP42841A

Test Instruments : Agilent E4991A Material/Impedance Analyzer

Typical L vs. Frequency

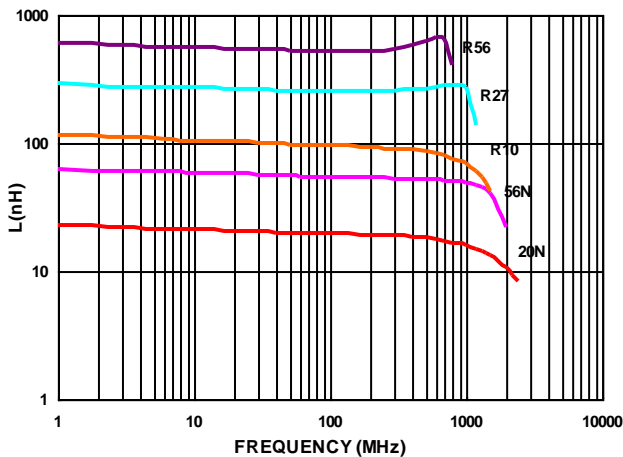

Typical Q vs. Frequency

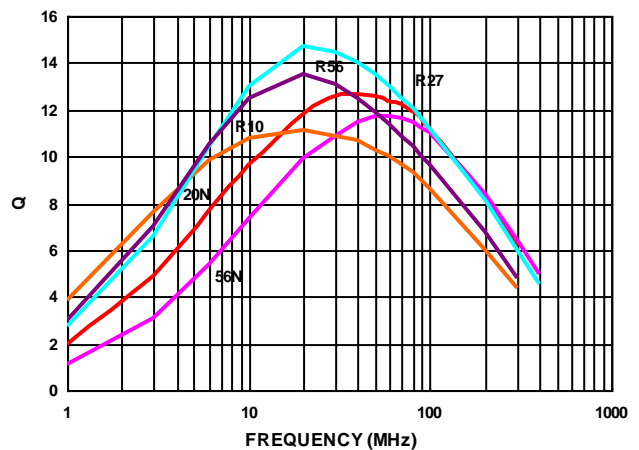

SMD Wire Wound Ferrite Chip Inductors – BWLS Series

Electrical Characteristics

Part Number	Inductance (uH)	Tolerance (±%)	Test Frequency (MHz)	Q Typ.	SRF (MHz) Min	RDC (Ω) Max	IDC (mA)	Color
BWLS0016110947N□00	0.047	10 / 5	7.9	17	1700	0.075	1500	Black
BWLS0016110972N□00	0.072	10 / 5	7.9	17	1700	0.12	1500	Brown
BWLS00161109R10□00	0.10	10 / 5	7.9	17	1650	0.13	1500	Red
BWLS00161109R12□00	0.12	10 / 5	7.9	17	1350	0.15	1500	Orange
BWLS00161109R15□00	0.15	10 / 5	7.9	17	1350	0.15	1450	Yellow
BWLS00161109R18□00	0.18	10 / 5	7.9	17	1150	0.15	1400	Green
BWLS00161109R22□00	0.22	10 / 5	7.9	17	1050	0.16	1350	Blue
BWLS00161109R24□00	0.24	10 / 5	7.9	17	1050	0.19	1300	Violet
BWLS00161109R27□00	0.27	10 / 5	7.9	17	1050	0.30	1050	Gray
BWLS00161109R33□00	0.33	10 / 5	7.9	17	850	0.46	1200	White
BWLS00161109R39□00	0.39	10 / 5	7.9	17	810	0.51	1200	Black
BWLS00161109R47□00	0.47	10 / 5	7.9	17	720	0.62	1050	Brown
BWLS00161109R56□00	0.56	10 / 5	7.9	17	600	0.44	850	Red
BWLS00161109R68□00	0.68	10 / 5	7.9	17	600	0.52	850	Orange
BWLS00161109R78□00	0.78	10 / 5	7.9	17	460	0.83	850	Yellow
BWLS00161109R82□00	0.82	10 / 5	7.9	17	480	0.69	750	Green
BWLS00161109R91□00	0.91	10 / 5	7.9	17	330	0.76	670	Black
BWLS001611091R0□00	1.0	10 / 5	7.9	18	310	0.81	600	Blue
BWLS001611091R2□00	1.2	10 / 5	7.9	17	270	0.87	550	Violet
BWLS001611091R5□00	1.5	10 / 5	7.9	17	270	1.06	540	Gray
BWLS001611091R8□00	1.8	10 / 5	7.9	17	230	1.10	520	White
BWLS001611092R2□00	2.2	10 / 5	7.9	17	140	1.20	500	Black
BWLS001611092R7□00	2.7	10 / 5	7.9	17	105	1.50	480	Brown
BWLS001611093R3□00	3.3	10 / 5	7.9	17	84	1.50	440	Red
BWLS001611093R9□00	3.9	10 / 5	7.9	17	80	1.60	430	Orange
BWLS001611094R7□00	4.7	10 / 5	7.9	18	69	2.10	420	Yellow
BWLS001611095R6□00	5.6	10 / 5	7.9	18	65	2.60	400	Green
BWLS001611096R8□00	6.8	10 / 5	7.9	19	55	3.10	400	Blue
BWLS001611097R8□00	7.8	10 / 5	7.9	17	47	3.50	400	Violet
BWLS001611098R2□00	8.2	10 / 5	7.9	17	42	3.80	400	Gray
BWLS00161109100□00	10	10 / 5	7.9	19	40	4.80	300	White

Note: When ordering, please specify tolerance code. Tolerance : J=±5% , K=±10%

- Operating temperature range - 25°C ~ 105°C(Including self - temperature rise)
- IDC for Inductance drop 10% from its value without current
- Measure Equipment :
 - L & Q : Agilent E4991A+Agilent HP16197A
 - SRF : Agilent HP8753D/Agilent E4991A
 - RDC : Chroma 16502
 - IDC : HP4284A+HP42841A/HP4285A+HP42841A

Test Instruments : Agilent E4991A Material/Impedance Analyzer

Typical L vs. Frequency

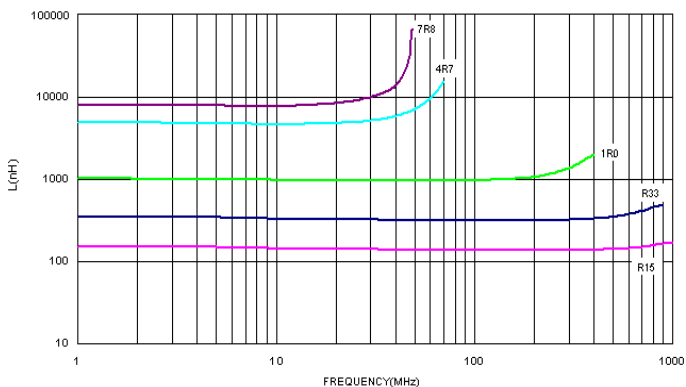

Typical Q vs. Frequency

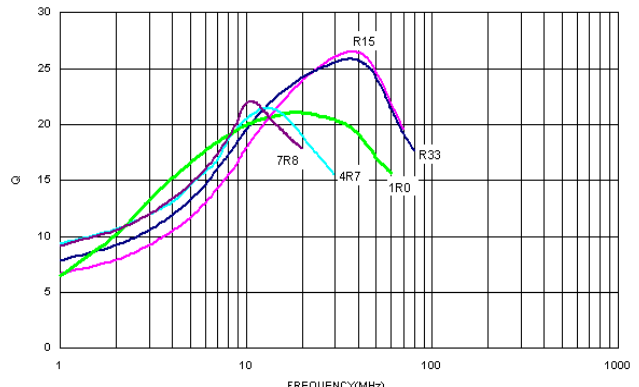

SMD Wire Wound Ferrite Chip Inductors – BWLS Series

Electrical Characteristics

Part Number	Inductance (uH)	Tolerance (±%)	Test Frequency (MHz)	Q Typ.	SRF (MHz) Min	RDC (Ω) Max	IDC (mA)	Color
BWLS0024171578N□00	0.078	10 / 5	7.9	19	1440	0.06	2000	Black
BWLS0024171590N□00	0.090	10	7.9	19	1200	0.07	2000	Red
BWLS00241715R11□00	0.11	10 / 5	7.9	19	1200	0.07	2000	Brown
BWLS00241715R47□00	0.47	10 / 5	7.9	19	480	0.40	800	Red
BWLS00241715R56□00	0.56	10 / 5	7.9	35	480	0.40	800	Yellow
BWLS00241715R68□00	0.68	10 / 5	7.9	20	480	0.40	800	Orange
BWLS00241715R91□00	0.91	10 / 5	7.9	20	400	0.69	700	Yellow
BWLS002417151R0□00	1.0	10 / 5	7.9	20	400	0.69	700	Yellow
BWLS002417151R2□00	1.2	10 / 5	7.9	20	330	0.83	700	Red
BWLS002417151R5□00	1.5	10 / 5	7.9	20	330	0.83	700	Green
BWLS002417151R8□00	1.8	10 / 5	7.9	20	300	1.00	650	Blue
BWLS002417152R2□00	2.2	10 / 5	7.9	20	250	1.10	650	Violet
BWLS002417152R7□00	2.7	10 / 5	7.9	23	200	1.25	650	Gray
BWLS002417153R3□00	3.3	10 / 5	7.9	23	160	1.45	650	White
BWLS002417153R9□00	3.9	10 / 5	7.9	23	90	1.50	600	Black
BWLS002417154R7□00	4.7	10 / 5	7.9	20	70	1.60	530	Brown
BWLS002417155R6□00	5.6	10 / 5	7.9	20	65	1.70	500	Red
BWLS002417156R8□00	6.8	10 / 5	7.9	20	45	1.95	470	Orange
BWLS002417158R2□00	8.2	10 / 5	2.5	16	45	2.10	450	Yellow
BWLS00241715100□00	10	10 / 5	2.5	16	40	2.40	400	Green
BWLS00241715120□00	12	10 / 5	2.5	16	38	3.20	360	Red
BWLS00241715150□00	15	10 / 5	2.5	16	30	3.55	350	Blue
BWLS00241715180□00	18	10 / 5	2.5	16	25	4.90	300	Orange
BWLS00241715220□00	22	10 / 5	2.5	16	20	5.45	270	Violet
BWLS00241715270□00	27	10 / 5	2.5	16	19	7.80	240	Gray
BWLS00241715330□00	33	10 / 5	2.5	16	16	9.50	210	White
BWLS00241715470□00	47	10 / 5	2.5	16	15	14.50	180	Brown

Note: When ordering, please specify tolerance code. Tolerance : J=±5% , K=±10%

- Operating temperature range - 25°C ~ 105°C(Including self - temperature rise)
- IDC for Inductance drop 10% from its value without current
- Measure Equipment :
 L & Q : Agilent E4991A+Agilent HP16197A
 SRF : Agilent E4991A
 RDC : HP4338B or Chroma 16502
 IDC : HP4284A+HP42841A/HP4285A+HP42841A

Test Instruments : Agilent E4991A Material/Impedance Analyzer

Typical **L** vs. **F** Frequency

Typical **Q** vs. **F** Frequency

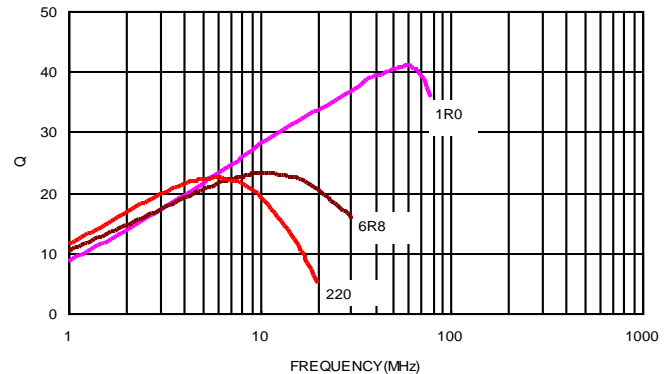
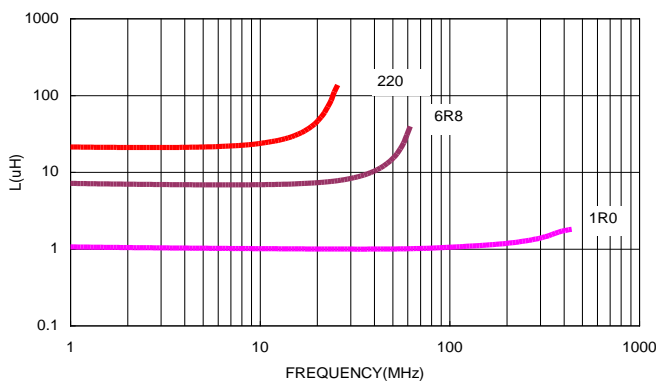

SMD Wire Wound Ferrite Chip Inductors – BWLS Series

Electrical Characteristics

Part Number	Inductance (uH)	Tolerance (±%)	Test Frequency (MHz)	Q Typ.	Test Frequency (MHz)	SRF (MHz) Min	RDC (Ω) Max	IDC (mA)	Color Coding		
									1 ST	2 ND	3 RD
BWLS003025221R2□00	1.2	10 / 5	7.9	55	50	350	0.50	1200	Brown	Red	Red
BWLS003025221R5□00	1.5	10 / 5	7.9	58	50	300	0.65	1200	Brown	Green	Red
BWLS003025221R8□00	1.8	10 / 5	7.9	54	50	280	0.75	1050	Brown	Gray	Red
BWLS003025222R2□00	2.2	10 / 5	7.9	48	50	250	0.90	950	Red	Red	Red
BWLS003025222R7□00	2.7	10 / 5	7.9	51	50	200	1.00	950	Red	Violet	Red
BWLS003025223R3□00	3.3	10 / 5	7.9	58	50	200	1.15	900	Orange	Orange	Red
BWLS003025223R9□00	3.9	10 / 5	7.9	37	7.9	170	1.25	850	Orange	White	Red
BWLS003025224R7□00	4.7	10 / 5	7.9	37	7.9	130	1.35	700	Yellow	Violet	Red
BWLS003025225R6□00	5.6	10 / 5	7.9	36	7.9	110	1.45	700	Green	Blue	Red
BWLS003025226R8□00	6.8	10 / 5	7.9	33	7.9	105	1.60	600	Blue	Gray	Red
BWLS003025228R2□00	8.2	10 / 5	7.9	40	7.9	90	1.80	550	Gray	Red	Red
BWLS00302522100□00	10	10 / 5	7.9	40	7.9	85	2.40	500	Brown	Black	Orange
BWLS00302522120□00	12	10 / 5	7.9	40	7.9	80	2.40	450	Brown	Red	Orange
BWLS00302522150□00	15	10 / 5	7.9	35	7.9	38	2.40	450	Brown	Green	Orange
BWLS00302522390□00	39	10 / 5	2.5	33	2.5	26	10	170	Orange	White	Orange

Note: When ordering, please specify tolerance code. Tolerance : J=±5% , K=±10%

- Operating temperature range - 25°C ~ 105°C(Including self - temperature rise)
- IDC for Inductance drop 10% from its value without current
- Measure Equipment :
 L & Q : Agilent E4991A+Agilent HP16197A
 SRF : Agilent E4991A
 RDC : HP4338B or Chroma 16502
 IDC : HP4284A+HP42841A/HP4285A+HP42841A

Test Instruments : Agilent E4991A Material/Impedance Analyzer

Typical L vs. Frequency

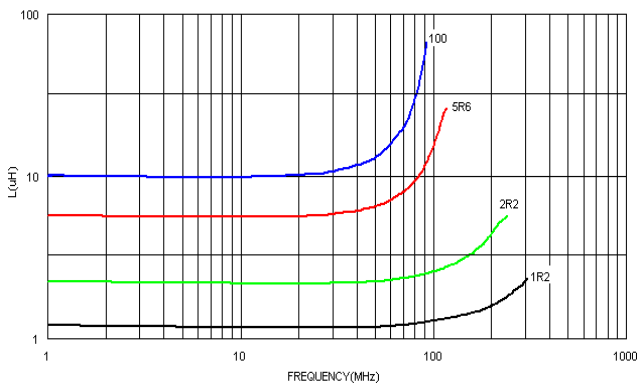

Typical Q vs. Frequency

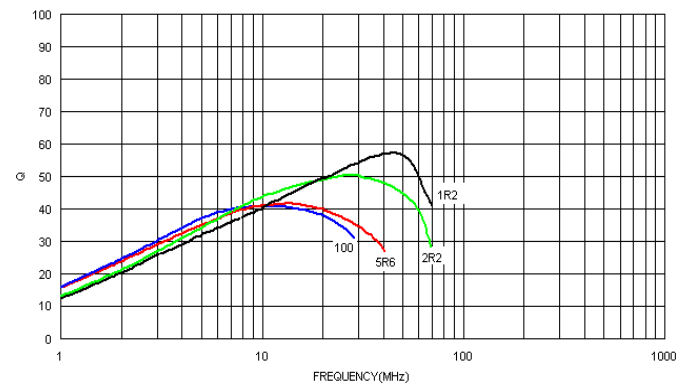

SMD Wire Wound Ferrite Chip Inductors - BWLS Series

Packaging Specifications

Tape Dimensions

Figure 1

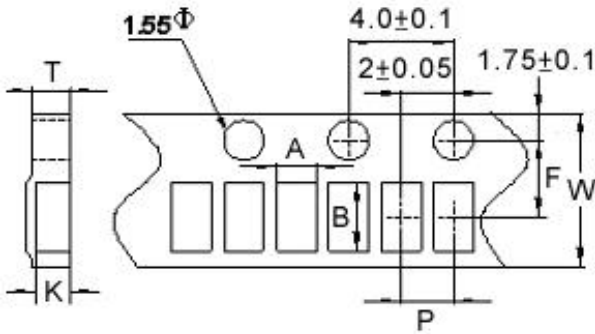

Figure 2

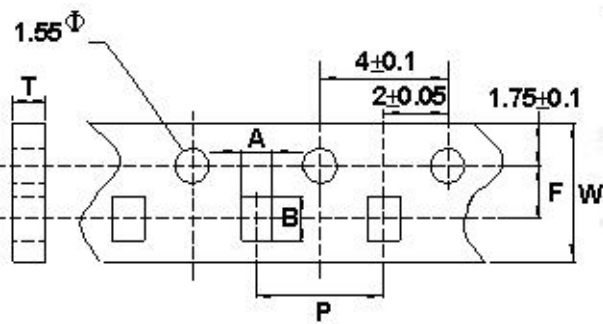
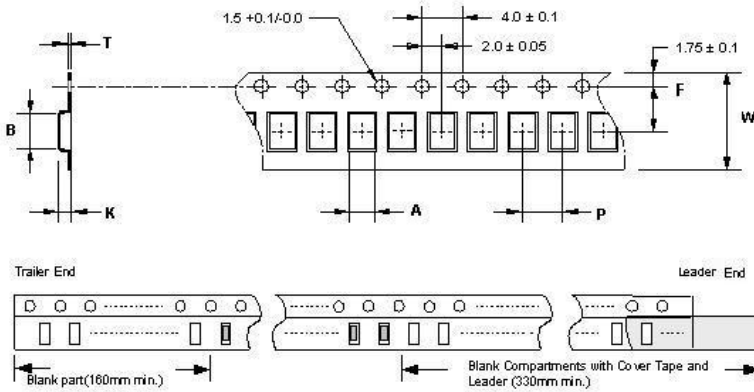
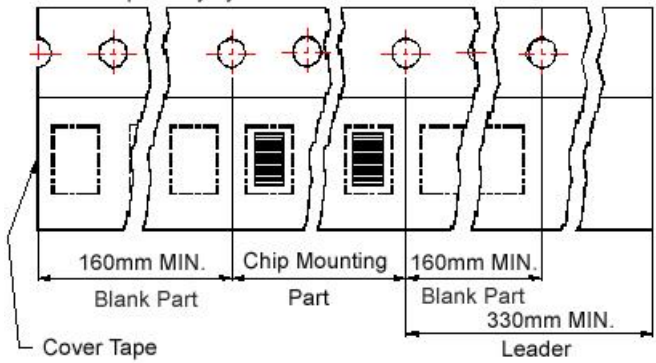

Figure 3



Tape Material

Carrier Tape: Paper
Cover Tape: Polystyrene



Carrier Tape: Paper
Cover Tape: Polystyrene

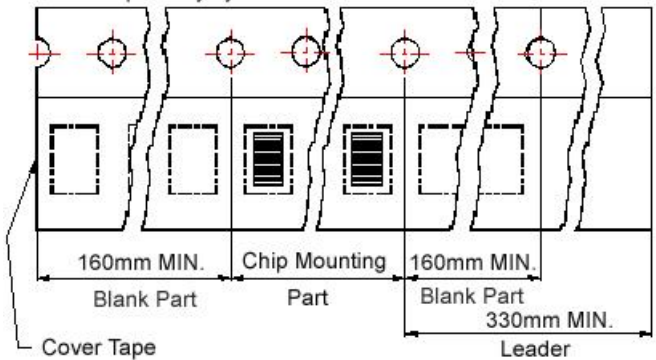

Reel Dimensions

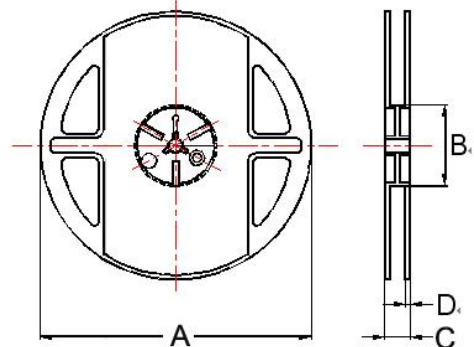

Dimensions in mm

TYPE	Fig.	Tape Dimensions							Reel Dimensions				Quantity PCS / REEL
		A	B	T	W	P	F	K	A	B	C	D	
BWLS00060404	1	0.44	0.64	0.61	8	2	3.5	0.45	178	60	12	1.5	4000
BWLS00100606	1	0.67	1.20	0.75	8	2	3.5	0.59	178	60	12	1.5	4000
BWLS00161109	2	1.25	1.90	1.05	8	4	3.5	-	178	60	12	1.5	4000
BWLS00241715	3	1.60	2.42	0.22	8	4	3.5	1.45	178	60	12	1.5	2000
BWLS00302522	3	2.40	2.93	0.26	8	4	3.5	2.25	178	60	12	1.5	2000