





-  Available in low profile and used in high power application
-  Large permissible DC current
-  Ideal for computers and portable power devices, DC-DC converters, energy storage applications and Input-Output filter applications
-  Operating temperature -40 C to +130 C
-  RoHS compliant



**ELECTRICAL SPECIFICATION @ 25°C**

Part Number	Rated Inductance ( H Typ)	Inductance <sup>2</sup> ( H 15%)	I <sub>rms</sub> <sup>3</sup> (A)	Isat <sup>4</sup> (A) Approx. 10%	Isat <sup>5</sup> (A) Approx. 15%	DCR (m Max)	Volts- Sec <sup>6</sup> Typ	Marking (YYYY)
SIS6572L-R10R	0.10	0.10	19.0	27.0	34.7	1.21	0.25	LR10
SIS6572L-R20R	0.20	0.22	15.3	16.0	20.8	1.88	0.42	LR20
SIS6572L-R47R	0.47	0.44	10.9	11.6	14.9	3.67	0.59	LR47
SIS6572L-R68R	0.68	0.72	9.72	9.0	11.6	4.63	0.76	LR68
SIS6572L-1R0R	1.00	1.10	6.26	7.4	9.5	11.2	0.92	L1R0
SIS6572L-1R5R	1.50	1.50	5.78	6.2	8.0	13.1	1.09	L1R5
SIS6572L-2R0R	2.00	2.00	5.40	5.4	6.9	15.0	1.26	L2R0
SIS6572L-3R3R	3.30	3.20	3.63	4.3	5.5	30.0	1.60	L3R3
SIS6572L-4R7R	4.70	4.70	3.23	3.5	4.2	40.0	1.93	L4R7
SIS6572L-8R2R	8.20	8.50	2.91	2.6	3.4	74.0	2.61	L8R2
SIS6572L-150R	15.00	14.90	2.22	2.0	2.5	127	3.45	L150

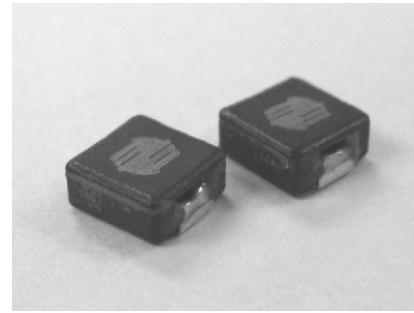
**Notes:**

1. Ordering Information: SIS6572a - bbbRc.

SIS6572 = Product Type.

a = Tolerance of Inductance (L = ±15%).

bbb = Inductance value in uH (i.e. R47 = 0.47uH; 4R7 = 4.7uH ).

R = Internal Control Code.

c = Packaging Code (T = Tape & Reel Packaging in 13 inch Reel).

2. Inductance is tested at 100kHz, 0.1V<sub>rms</sub>, 0Adc.

3. Heating current, I<sub>rms</sub>, is the current required to raise the component temperature by approximately 40 C, excluding the core loss.

4. Saturation current, Isat, is the DC current at which the inductance of the component drops by approximately 10%.

5. Saturation current, Isat, is the DC current at which the inductance of the component drops by approximately 15%.

6. This value represents the applied V- S at 500kHz necessary to generate a core loss equal to 10% of the total losses for 40 C temperature rise.

7. The part temperature (ambient temperature + temperature rise) should not exceed the upper limit of the operating temperature under worst case operating conditions. Circuit design, component placement, PWB trace size and thickness, airflow and other cooling provisions all affect the part temperature. Part temperature should be verified in the end application.



**MECHANICAL DIMENSIONS**

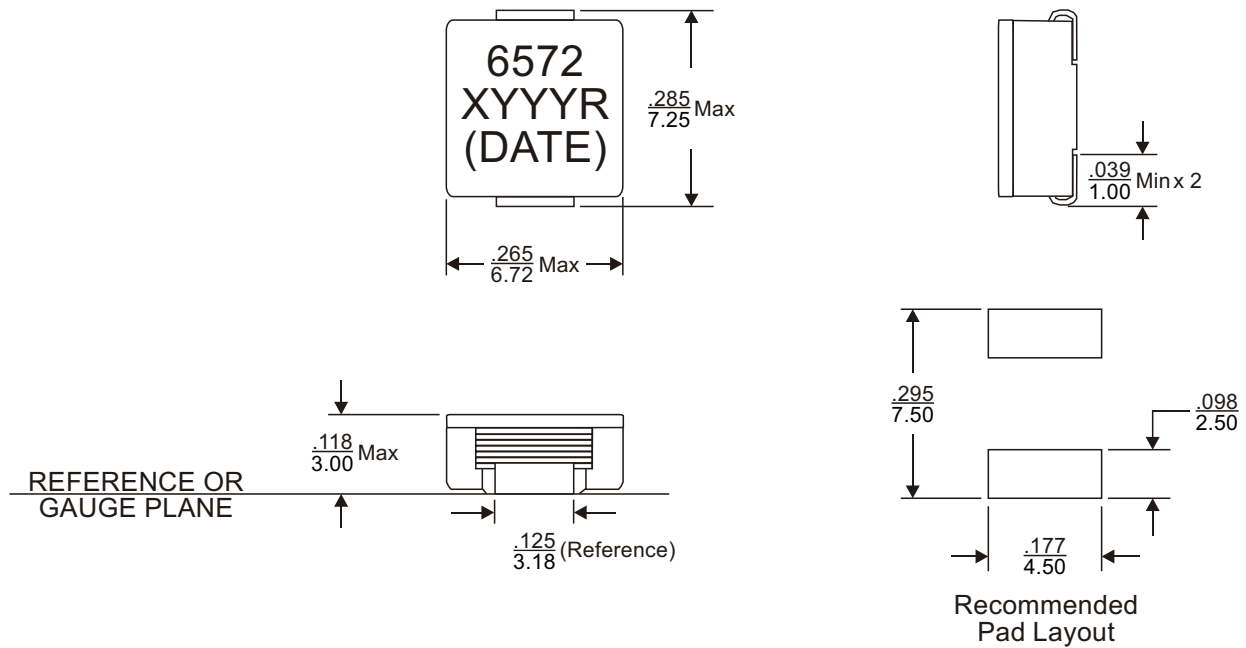

**Notes:**

- 8. All dimensions are specified in inches with higher precedence in mm.
- 9. Unless otherwise specified, all tolerances are  $\pm \frac{.010}{0.25}$ .

Weight (in gram)	: 1.0 typ.
Tape & Reel	: 1500 / reel

**SCHEMATIC**

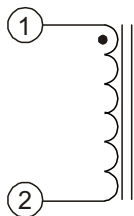

**PACKAGING**

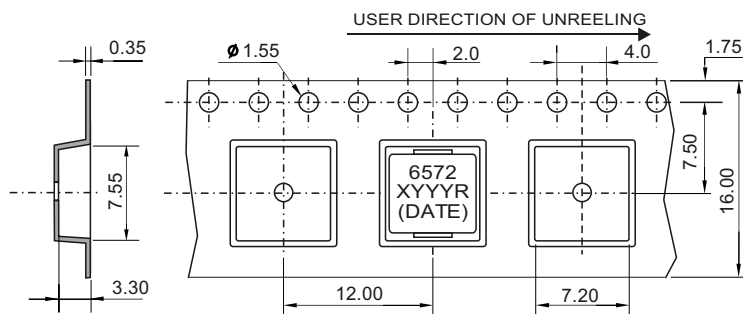

**FOR MORE INFORMATION, PLEASE CONTACT**

**HEADQUARTER**

1/F., Harbour View 1, No.12 Science Park East Avenue,  
Phase II, Hong Kong Science Park, Shatin, N.T.  
Hong Kong

Tel: (852) 2954 3333 Fax: (852) 2954 3304

Email: eempl@eleceltek.com

Website: <http://www.eleceltek.com> / [www.eemagnetic.com](http://www.eemagnetic.com)

Information herein is for reference only and subject to change without notice. It does not constitute any representation, warranty or commitment of the company in respect of the products in any aspect. All logos, brands and product names mentioned herein are trademarks or registered trademarks of their respective owners. The company does not assume any liability arising out of the application or use of any product or circuit described herein. Copyrights 2009, E & E Magnetic Products Limited.