

Chip Bead ABSJ Series

**Automotive
AEC-Q200**

RoHS Compliant
Halogen Free
REACH Compliant



Noise
Suppression

Shield

Multilayer

Ferrite

General
Signal line

Part Numbering

A	BSJ	00	100505	600	Y	00
Grade	Series Name	Control Code	Dimensions Code (mm)	Impedance (Ω)	Tolerance	Internal Code
			100505 1.0x0.5x0.5	600 60	Y ±25%	
			160808 1.6x0.8x0.8	121 120		
				102 1000		

This specification applies to Multilayer Chip ferrite Bead for Automotive Electronics based on AEC-Q200 except for Power train and Safety.

Chip Bead ABSJ Series

Automotive
AEC-Q200

ABSJ00100505 Type

■ Dimensions

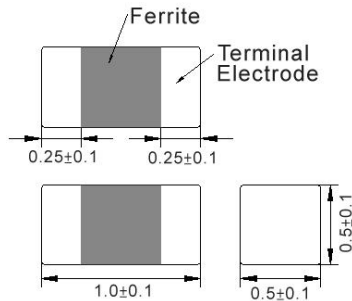

unit:mm

■ Recommended Land Pattern

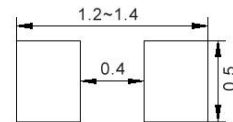

unit:mm

■ Electrical Characteristics

Part No.	Impedance (Ω)	Test Freq.	RDC (Ω)Max.	Rated Current (mA)Max.
ABSJ00100505300Y00	30	100 MHz, 200 mV	0.20	500
ABSJ00100505600Y00	60	100 MHz, 200 mV	0.20	500
ABSJ00100505121Y00	120	100 MHz, 200 mV	0.25	500
ABSJ00100505221Y00	220	100 MHz, 200 mV	0.40	400
ABSJ00100505301Y00	300	100 MHz, 200 mV	0.50	300
ABSJ00100505481Y00	480	100 MHz, 200 mV	0.50	300
ABSJ00100505601Y00	600	100 MHz, 200 mV	0.60	300
ABSJ00100505102Y00	1000	100 MHz, 200 mV	0.95	200
ABSJ00100505152Y00	1500	100 MHz, 200 mV	1.15	100

Note: When ordering, please specify tolerance code. Tolerance: $Y = \pm 25\%$

- Operating temperature range - $40^{\circ}\text{C} \sim 125^{\circ}\text{C}$
- Rate Current : Applied the current to coils, the temperature rise shall not be more than 30°C
- Measure Equipment:
Z: HP4291A
RDC: HP4338B or CHEN HWA 502

ABSJ00100505 Type

Characteristics Graph

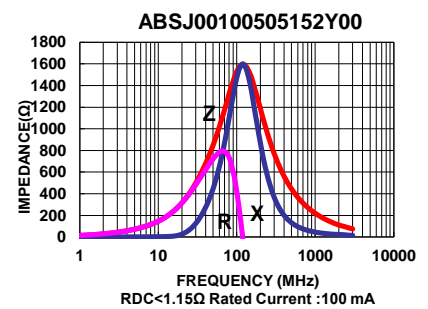
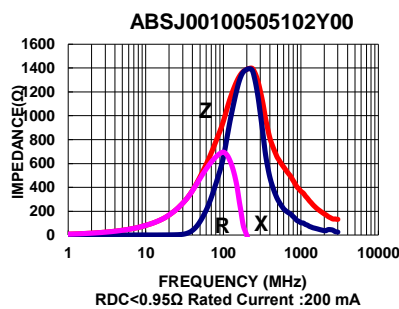
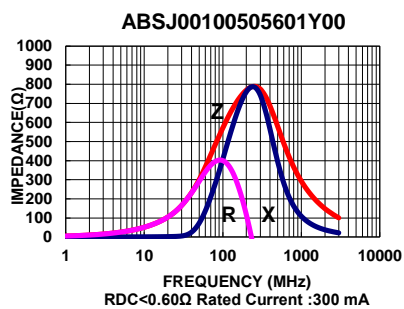
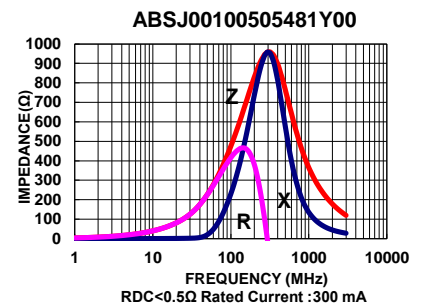
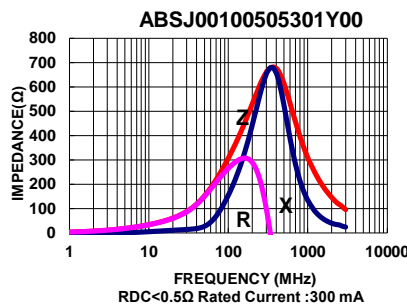
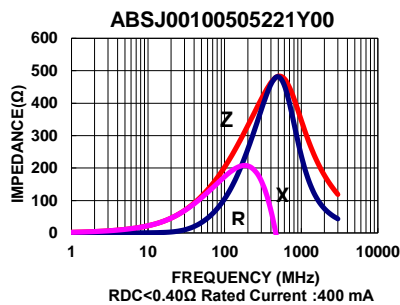
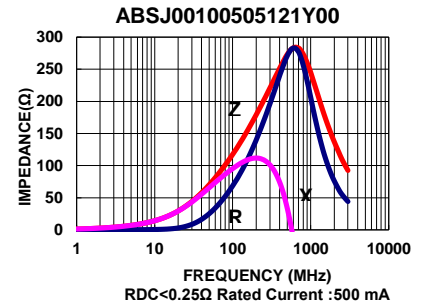
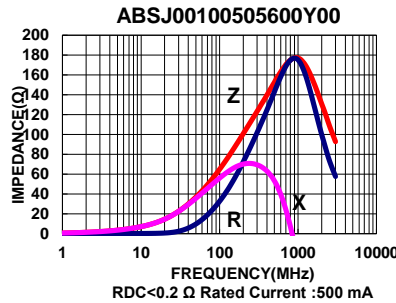
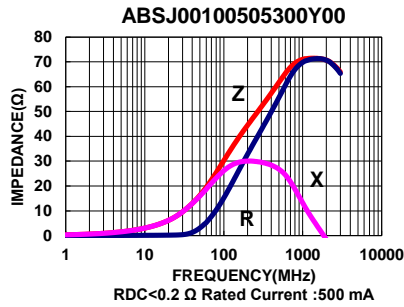

Chip Bead ABSJ Series

Automotive
AEC-Q200

ABSJ00160808 Type

■ Dimensions

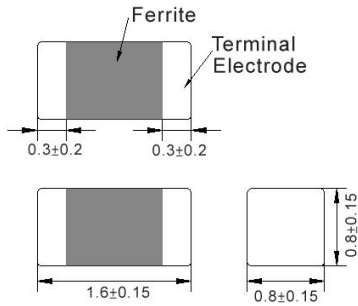

unit:mm

■ Recommended Land Pattern

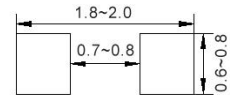

unit:mm

■ Electrical Characteristics

Part No.	Impedance (Ω)	Test Freq.	RDC (Ω)Max.	Rated Current (mA)Max.
ABSJ00160808121Y00	120	100 MHz, 200 mV	0.25	400
ABSJ00160808601Y00	600	100 MHz, 200 mV	0.40	400
ABSJ00160808102Y00	1000	100 MHz, 200 mV	0.60	300
ABSJ00160808182Y00	1800	100 MHz, 200 mV	1.00	200
ABSJ00160808252Y00	2500	100 MHz, 200 mV	1.00	200

Note: When ordering, please specify tolerance code. Tolerance: $Y = \pm 25\%$

- Operating temperature range - $40^{\circ}\text{C} \sim 125^{\circ}\text{C}$
- Rate Current : Applied the current to coils, the temperature rise shall not be more than 30°C
- Measure Equipment:
 - Z: HP4291A
 - RDC: HP4338B or CHEN HWA 502

ABSJ00160808 Type

■ Characteristics Graph

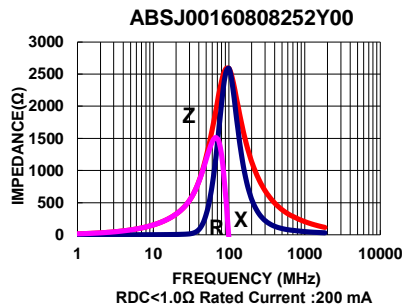
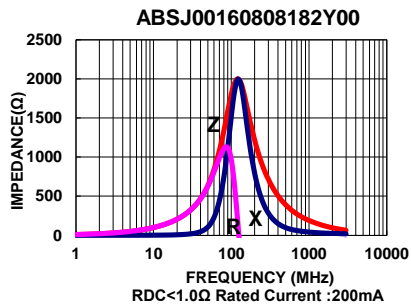
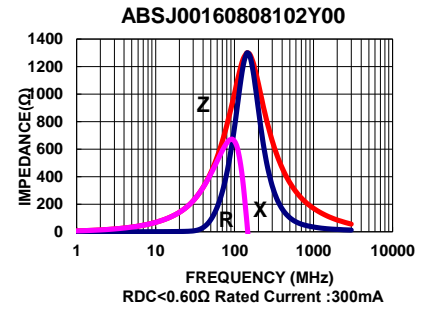
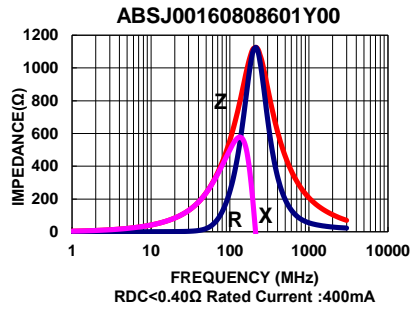
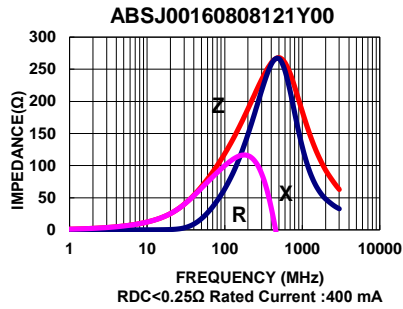

Chip Bead ABSJ Series

Automotive
AEC-Q200

■ Packaging

Tape Dimensions

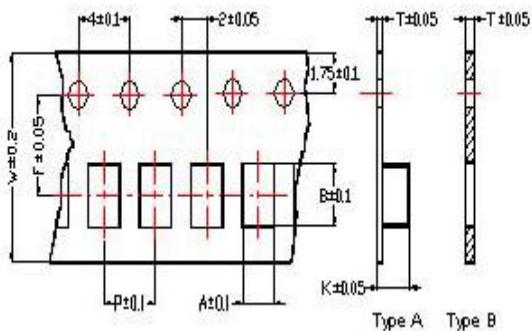

Tape Material

Carrier Tape: Polycarbonate (Tape A)
Carrier Tape: Paper (Tape B)
Cover Tape: Polystyrene

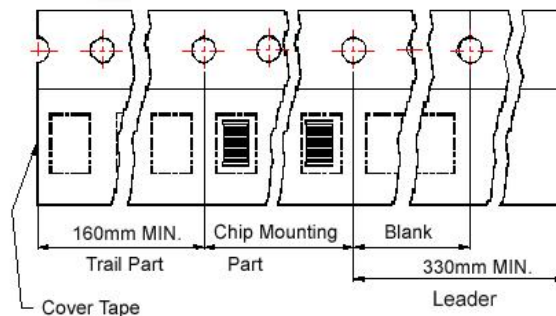

Reel Dimensions

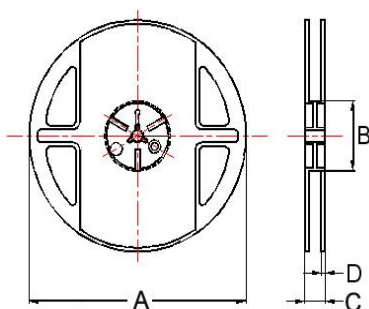

Dimensions in mm

TYPE	Tape Dimensions								Reel Dimensions				Quantity
	A	B	T	W	P	F	K	Tape	A	B	C	D	PCS / Reel
ABSJ00100505	0.62	1.12	0.60	8	2	3.5	-	B	178	60	12	2	10000
ABSJ00160808	1.05	1.85	0.95	8	4	3.5	-	B	178	60	12	2	4000