

BPSA Series

Features

- RoHS, Halogen Free and REACH Compliance
- Magnetically shielded type
- Cost effective
- Low DCR

Applications

- TV
- Laptop
- Mainboard
- Automotive devices
- Commercial devices

Product Identification

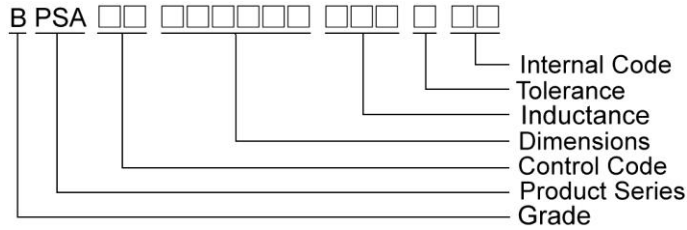

Shape and Dimensions

BPSA00060630

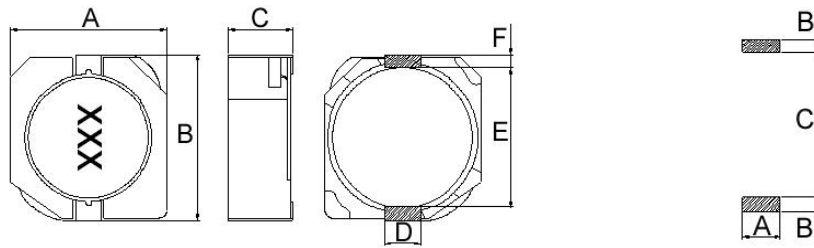

Recommended Pattern

Dimensions in mm

TYPE	Shape and Dimensions						Recommended Pattern		
	A	B	C	D	E	F	A	B	C
BPSA00060630	6.3 ⁺⁰	6.3 ⁺⁰	3.0 ⁺⁰	2.0	4.0	0.9	2.2	1.5	4.0

BPSA00070748/070758/131358

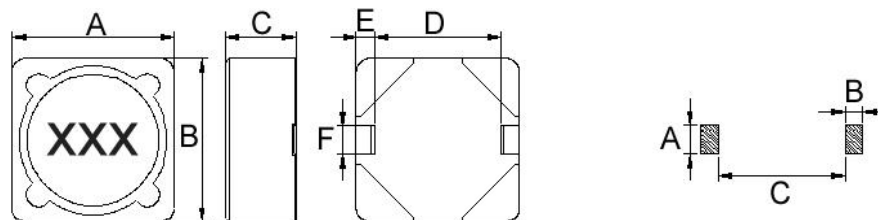

Dimension in mm

TYPE	Shape and Dimensions						Recommended Pattern		
	A	B	C	D	E	F	A	B	C
BPSA00070748	7.3±0.2	7.3±0.2	4.8 ⁺⁰	5.5	0.9	2.0	2.2	1.5	4.8
BPSA00070758	7.3±0.2	7.3±0.2	5.8 ⁺⁰	5.5	0.9	2.0	2.2	1.5	4.8
BPSA00131358	12.5 ⁺⁰	12.5 ⁺⁰	5.8 ⁺⁰	8.0	2.0	2.7	3.2	2.6	7.5

SMD Shielded Power Inductors – BPSA Series

Standard Specifications

Part Number	Inductance (uH)	Tolerance (±%)	Test Frequency (kHz)	SRF (MHz) Min	RDC (mΩ) Max	Isat (A)	Irms (A)	Marking
BPSA000606306R8T00	6.8	30	100	35	42	1.50	2.20	6R8
BPSA00060630100M00	10	20	100	20	63.8	1.30	1.80	100
BPSA00060630150M00	15	20	100	15	89.4	1.00	1.40	150
BPSA00060630220M00	22	20	100	10	124	0.77	1.30	220
BPSA00060630330M00	33	20	100	7	177	0.69	1.10	330
BPSA00060630470M00	47	20	100	5	252	0.59	0.92	470
BPSA00060630680M00	68	20	100	4	348	0.50	0.78	680
BPSA00060630101M00	100	20	100	4	516	0.42	0.64	101
BPSA00060630151M00	150	20	100	4	780	0.34	0.50	151
BPSA00060630221M00	220	20	100	3.2	1170	0.26	0.38	221

Note: When ordering, please specify tolerance code. Tolerance: M=±20% , T=±30%

- Operating temperature range - 40°C ~ 125°C(Including self - temperature rise)
- Isat for Inductance drop 30% from its value without current
- I rms for a 25°C temprature rise from 25°C ambient
- Measure Equipment :
 L : L: WK6500B+WK6565, 100kHz/ 1V
 RDC : Chroma 16502
 Isat : WK3260B+WK3265B

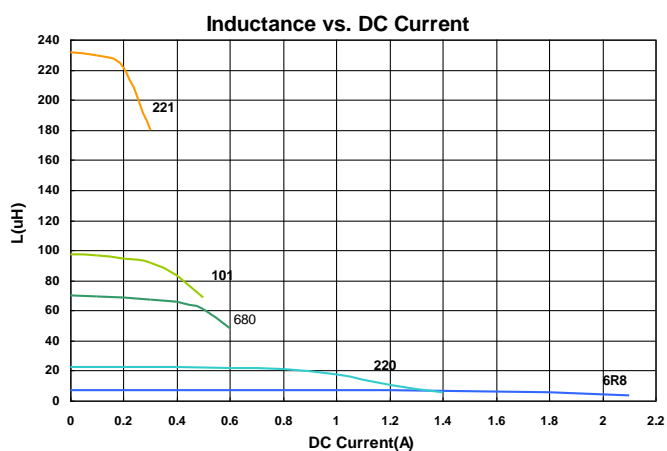
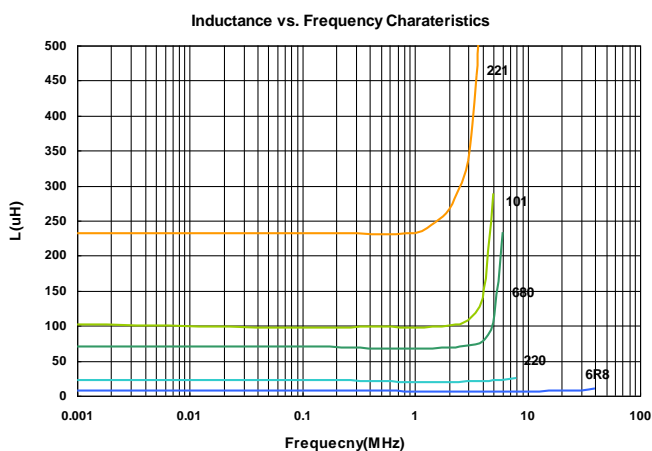

SMD Shielded Power Inductors – BPSA Series

Standard Specifications

Part Number	Inductance (uH)	Tolerance (±%)	Test Frequency (kHz)	SRF (MHz) Min	RDC (mΩ) Max	Isat (A)	Irms (A)	Marking
BPSA000707483R3M00	3.3	20	100	90	24	2.50	2.30	3R3
BPSA000707484R7M00	4.7	20	100	65	36	2.00	2.10	4R7
BPSA000707486R8M00	6.8	20	100	24	40	1.70	1.74	6R8
BPSA00070748100M00	10	20	100	17	43.2	1.30	1.78	100
BPSA00070748150M00	15	20	100	14	62.4	1.10	1.53	150
BPSA00070748220M00	22	20	100	10.5	73.2	0.90	1.34	220
BPSA00070748330M00	33	20	100	10.0	115	0.82	1.09	330
BPSA00070748470M00	47	20	100	8.0	150	0.75	0.92	470
BPSA00070748680M00	68	20	100	7.0	210	0.60	0.77	680
BPSA00070748101M00	100	20	100	6.0	300	0.50	0.65	101
BPSA00070748151M00	150	20	100	4.0	408	0.40	0.55	151
BPSA00070748221M00	220	20	100	3.5	624	0.33	0.45	221
BPSA00070748331M00	330	20	100	3.0	880	0.25	0.37	331
BPSA00070748471M00	470	20	100	2.5	1260	0.22	0.31	471
BPSA00070748681M00	680	20	100	2.1	1770	0.20	0.27	681
BPSA00070748102M00	1000	20	100	1.1	2730	0.14	0.25	102

Note: When ordering, please specify tolerance code. Tolerance: M=±20%

- Operating temperature range - 40°C ~ 125°C(Including self - temperature rise)
- Isat for Inductance drop 10% from its value without current
- Irms for a 20°C temprature rise from 25°C ambient
- Measure Equipment :
 L : L: WK6500B+WK6565, 100kHz/ 1V
 RDC : Chroma 16502
 Isat : WK3260B+WK3265B

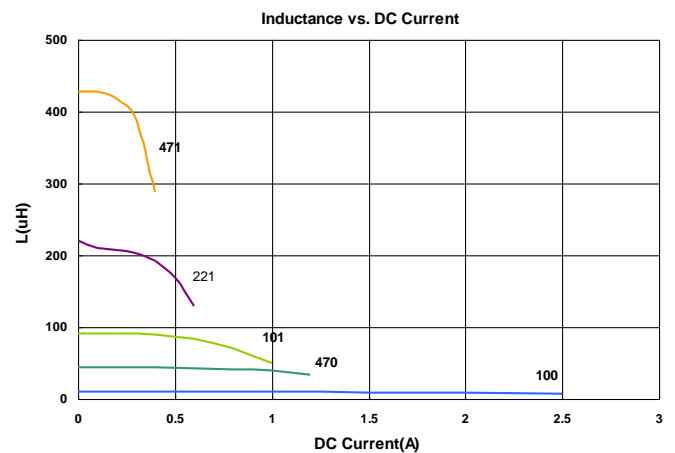
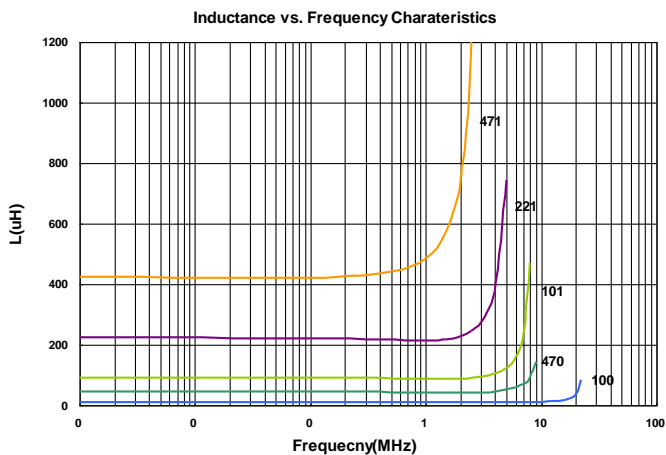

Please be sure to request approval specifications that provide further details of the products. Kindly note that the content of these specifications are subject to change or may be discontinued without prior notice. This product may not be designed/used in medical or high risk applications without Chilisin approval. Please contact our sales department before ordering.

SMD Shielded Power Inductors – BPSA Series

Standard Specifications

Part Number	Inductance (uH)	Tolerance (±%)	Test Frequency (kHz)	SRF (MHz) Min	RDC (mΩ) Max	Isat (A)	Irms (A)	Marking
BPSA000707581R5T00	1.5	30	100	75	20	6.2	4.0	1R5
BPSA000707582R2T00	2.2	30	100	55	23	5.3	3.5	2R2
BPSA000707583R3T00	3.3	30	100	48	31	4.3	3.3	3R3
BPSA000707584R7T00	4.7	30	100	38	36	3.6	3.1	4R7
BPSA000707586R8T00	6.8	30	100	35	44	3.0	2.8	6R8
BPSA00070758100M00	10	20	100	22	46	2.6	2.5	100
BPSA00070758150M00	15	20	100	14	60.9	2.1	2.2	150
BPSA00070758220M00	22	20	100	8	77	1.7	2.0	220

Note: When ordering, please specify tolerance code. Tolerance: M=±20% , T=±30%

- Operating temperature range - 40°C ~ 125°C(Including self - temperature rise)
- Isat for Inductance drop 10% from its value without current
- I rms for a 30°C temprature rise from 25°C ambient.
- Measure Equipment :
 L : L: WK6500B+WK6565, 100kHz/ 1V
 RDC : Chroma 16502
 Isat : WK3260B+WK3265B

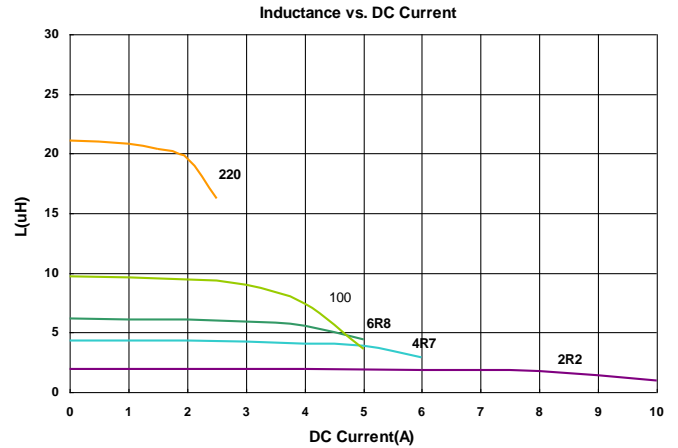
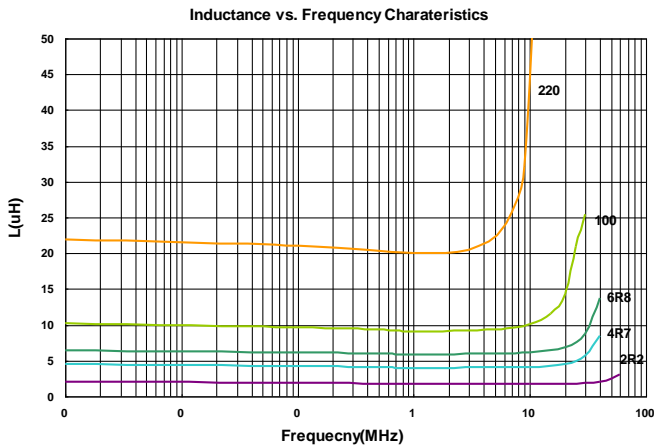

SMD Shielded Power Inductors – BPSA Series

Standard Specifications

Part Number	Inductance (uH)	Tolerance (±%)	Test Frequency (kHz)	SRF (MHz) Min	RDC (mΩ) Max	Isat (A)	Irms (A)	Marking
BPSA001313586R0T00	6	30	1	26	19.7	3.6	4.9	6R0
BPSA00131358100M00	10	20	1	17	25.8	3.4	4.3	100
BPSA00131358150M00	15	20	1	15	31.0	2.8	3.9	150
BPSA00131358220M00	22	20	1	11	40.6	2.3	3.4	220
BPSA00131358330M00	33	20	1	10	49.8	1.9	3.1	330
BPSA00131358470M00	47	20	1	8	74.2	1.6	2.5	470
BPSA00131358680M00	68	20	1	7	99.8	1.3	2.2	680
BPSA00131358101M00	100	20	1	5.5	140	1.1	1.8	101
BPSA00131358151M00	150	30	1	4.5	228	0.88	1.4	151
BPSA00131358221M00	220	20	1	3.0	324	0.72	1.2	221
BPSA00131358331M00	330	20	1	3.0	492	0.59	1.0	331
BPSA00131358471M00	470	20	1	2.5	624	0.49	0.88	471
BPSA00131358681M00	680	20	1	2.0	912	0.43	0.73	681
BPSA00131358102M00	1000	20	1	1.7	1344	0.34	0.60	102
BPSA00131358152M00	1500	20	1	1.4	2076	0.29	0.48	152

Note: When ordering, please specify tolerance code. Tolerance: M=±20% , T=±30%

- Operating temperature range - 40°C ~ 125°C(Including self - temperature rise)
- Isat for Inductance drop 10% from its value without current
- Irms for a 30°C temprature rise from 25°C ambient.
- Measure Equipment :
 L : L: WK6500B+WK6565, 1kHz/ 1V
 RDC : Chroma 16502
 Isat : WK3260B+WK3265B

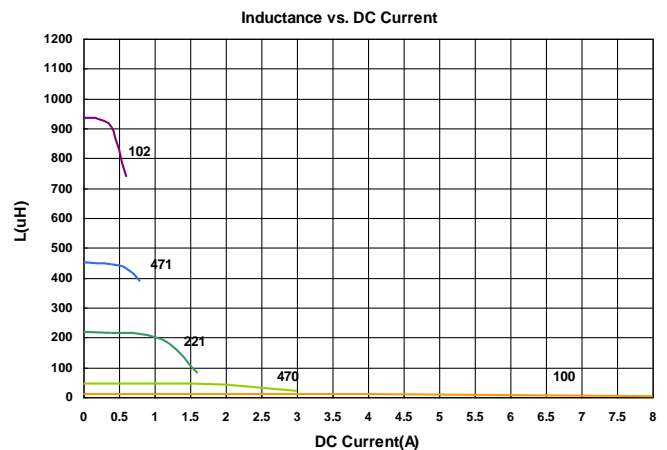
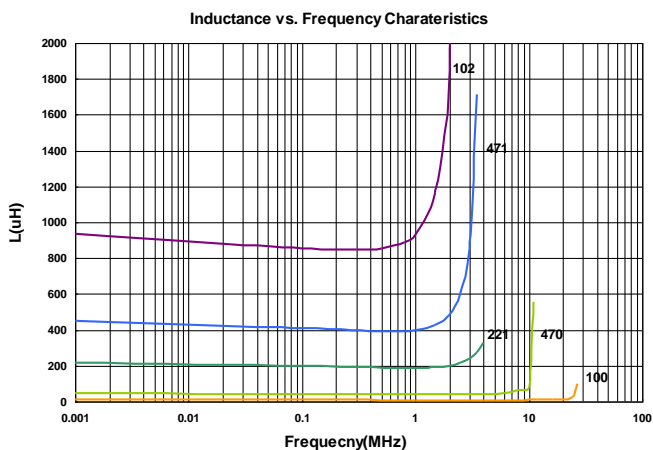

Packaging Specifications

Tape Dimensions

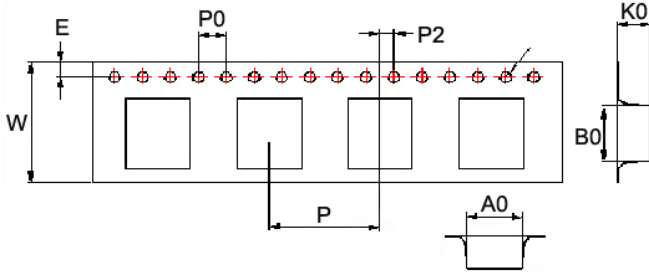

Tape Material

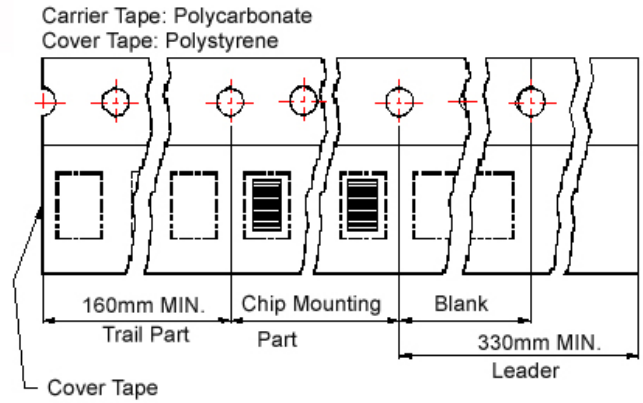

Reel Dimensions

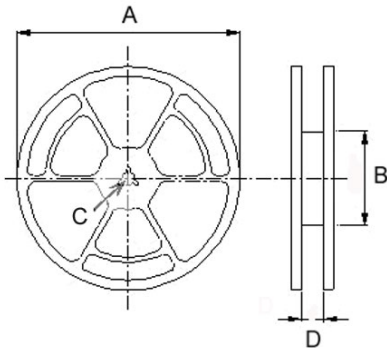

Dimensions in mm

TYPE	Tape Dimensions									Reel Dimensions				Quantity PCS / REEL
	A0	B0	K0	D	E	W	P	P0	P2	A	B	C	D	
BPSA00060630	6.3	6.55	3.3	1.55	1.75	16	12	4	2	330	100	13	16.0	1000
BPSA00070748	7.6	7.6	5.2	1.55	1.75	16	12	4	2	330	100	13	16.0	1000
BPSA00070758	7.8	7.8	6.0	1.55	1.75	16	12	4	2	330	100	13	16.0	900
BPSA00131358	12.6	12.6	6.7	1.55	1.75	24	16	4	2	330	100	13	24.2	600