

BMCx Series



BMCx series is designed for low profile type with low RDC and ultra large current. Its molded magnetic shielded type is suitable for high-density mounting and ultra low buzz noise. Soldering conditions can be easily confirmed when mounting onto the board. This series also provides customers with embossed carrier type packaging for automatic mounting machine.

Features

- RoHS, Halogen Free and REACH Compliance
- High rated current
- Ultra low buzz noise

Applications

- Laptops and PCs
- Switches and servers
- Base stations
- DC/DC converters

Product Identification

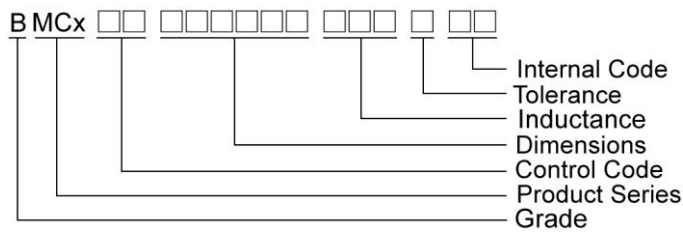

Shape and Dimensions

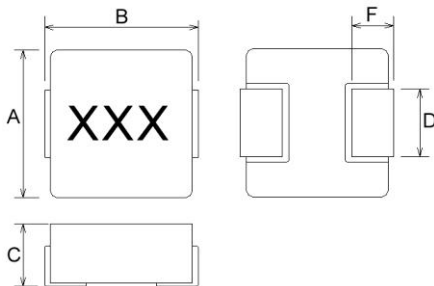

Recommended Pattern

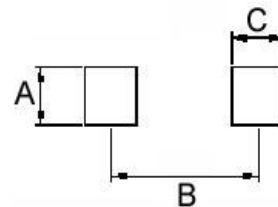

Dimensions in mm

TYPE	A	B	C	D	F
BMCB00060615	6.6±0.2	6.95±0.35	1.3±0.2	3.0±0.3	1.6±0.5
BMCA00060630	6.6±0.2	6.95±0.35	2.8±0.2	3.0±0.3	1.6±0.5
BMCA00101040	10.2±0.3	11.6Max	3.8±0.2	2.5±0.5 3.0±0.5	2.5±0.5

Dimensions in mm

TYPE	A	B	C
BMCA00060615	3.5	6.05	2.35
BMCA00060630	3.5	6.05	2.35
BMCA00101040	4.0	9.5	3.5

Molding Power Inductors – BMCx Series

Electrical Characteristics

Part Number	Inductance (uH)	Tolerance (±%)	Test Frequency (kHz)	RDC(mΩ) Max(Typ)	Isat(A) Max(Typ).	Irms(A) Max(Typ).	Marking
BMCB00060615R33MA1	0.33	20	100	6.5(5.6)	19(21)	12(13.5)	R33
BMCB00060615R47MA1	0.47	20	100	8.5(7.2)	15.5(18)	11(13)	R47
BMCB000606151R0MA1	1.0	20	100	21(18.5)	10(12)	7.6(8.2)	1R0
BMCB000606151R5MA1	1.5	20	100	28(25)	7.7(8.5)	6.7(7.2)	1R5
BMCB000606152R2MA1	2.2	20	100	42(35)	6.1(7.2)	5.1(6.0)	2R2

Note: When ordering, please specify tolerance code. Tolerance: M=±20%

- Operating temperature range - 55°C ~ 125°C(Including self - temperature rise)
- Isat for Inductance drop 30% from its value without current
- I rms for a 40°C temperature rise from 25°C ambient with current
- Absolute maximum voltage 30VDC
- Measure Equipment :
 L : WK 3260B or WK 6500P, 100KHz 0.5V
 RDC : CHEN HWA 502 or CHEN HWA 46502B
 I rms : CHROMA 1810

Test Instruments : WK3260B Impedance / Material Analyzer

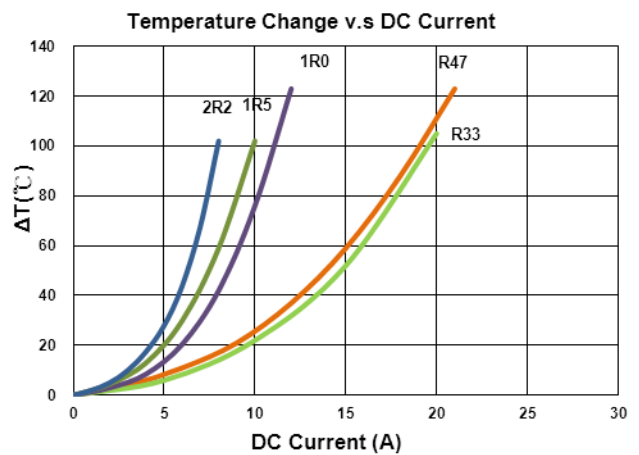
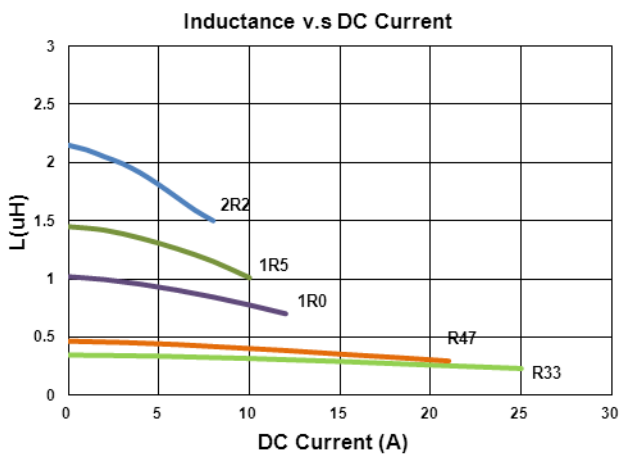

Molding Power Inductors – BMCx Series

Electrical Characteristics

Part Number	Inductance (uH)	Tolerance (±%)	Test Frequency (kHz)	RDC (mΩ) Max	Isat (A)Typ.	Irms (A)Typ.	Marking.
BMCA00060630R10MD1	0.10	20	100	1.7	60	32.5	R10
BMCA00060630R22MD1	0.22	20	100	2.8	40	23.0	R22
BMCA00060630R33MD1	0.33	20	100	3.9	30	20.0	R33
BMCA00060630R47MD1	0.47	20	100	4.2	26	17.5	R47
BMCA00060630R68MD1	0.68	20	100	5.5	25	15.5	R68
BMCA00060630R82MD1	0.82	20	100	8.0	24	13.0	R82
BMCA000606301R0MD1	1.0	20	100	10	22	11.0	1R0
BMCA000606301R5MD1	1.5	20	100	15	18	9.0	1R5
BMCA000606302R2MD1	2.2	20	100	20	14	8.0	2R2
BMCA000606303R3MD1	3.3	20	100	30	13.5	6.0	3R3
BMCA000606304R7MD1	4.7	20	100	40	10.0	5.5	4R7
BMCA000606306R8MD1	6.8	20	100	60	8.0	4.5	6R8
BMCA00060630100MD1	10	20	100	102	7.0	3.0	100

Note: When ordering, please specify tolerance code. Tolerance: M=±20%

- Operating temperature range - 55°C ~ 125°C(Including self - temperature rise)
- Isat for Inductance drop 20% from its value without current
- I rms for a 40°C temperature rise from 25°C ambient with current
- Absolute maximum voltage 30VDC
- Measure Equipment :
 L : WK 3260B or WK 6500P, 100KHz 0.5V
 RDC : CHEN HWA 502 or CHEN HWA 46502B
 I rms : CHROMA 1810

Test Instruments : WK3260B Impedance / Material Analyzer

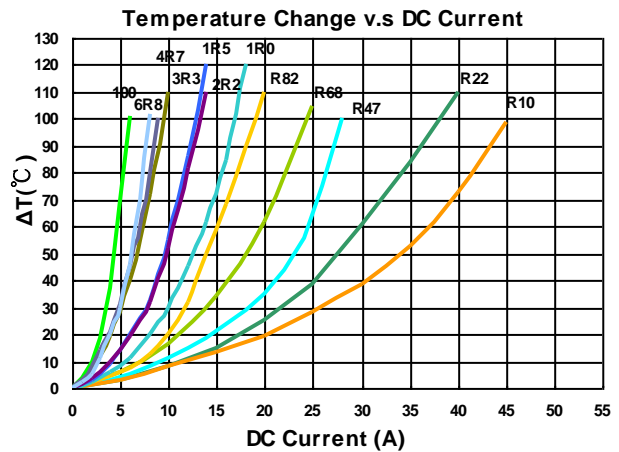
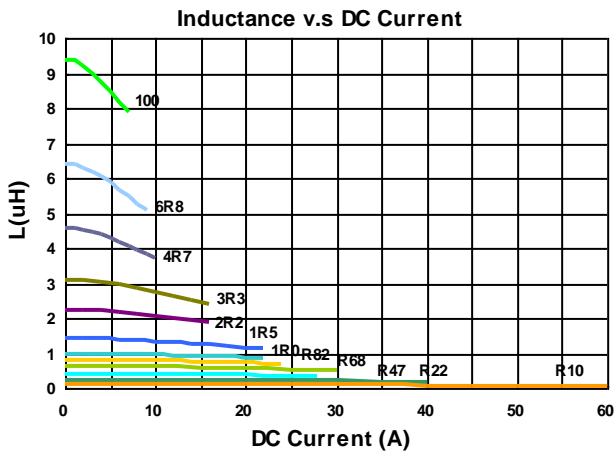

Molding Power Inductors – BMCx Series

Electrical Characteristics

Part Number	Inductance (uH)	Tolerance (±%)	Test Frequency (kHz)	RDC(mΩ) Max(Typ)	Isat (A)Typ.	Irms (A)Typ.	Marking
BMCA001010401R0MD1	1.0	20	100	3.2(2.7)	36	18	1R0
BMCA001010401R5MD1	1.5	20	100	4.2(3.8)	33	16	1R5
BMCA001010402R2MA1	2.2	20	100	7(6.4)	27	12	2R2
BMCA001010403R3MA1	3.3	20	100	12(10)	23	10	3R3
BMCA001010404R7MA1	4.7	20	100	16.5(15)	17	9.5	4R7

Note: When ordering, please specify tolerance code. Tolerance: M=±20%

- Operating temperature range - 55°C ~ 125°C(Including self - temperature rise)
- Isat for Inductance drop 30% from its value without current
- Irms for a 40°C temperature rise from 25°C ambient with current
- Absolute maximum voltage 30VDC
- Measure Equipment :
 L : WK 3260B or WK 6500P, 100kHz 0.5V
 RDC : CHEN HWA 502 or CHEN HWA 46502B
 Irms : CHROMA 1810

Test Instruments : WK3260B Impedance / Material Analyzer

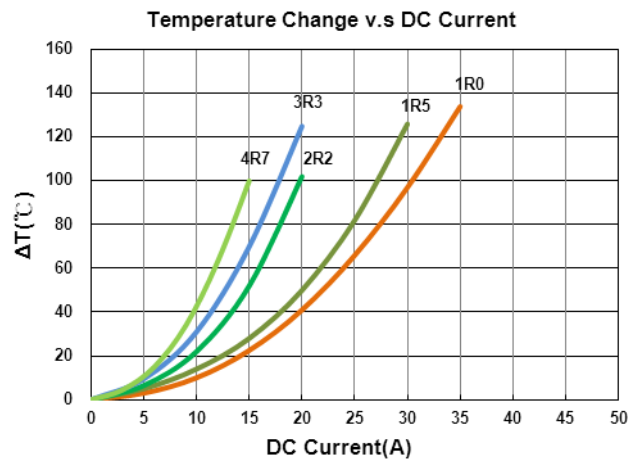
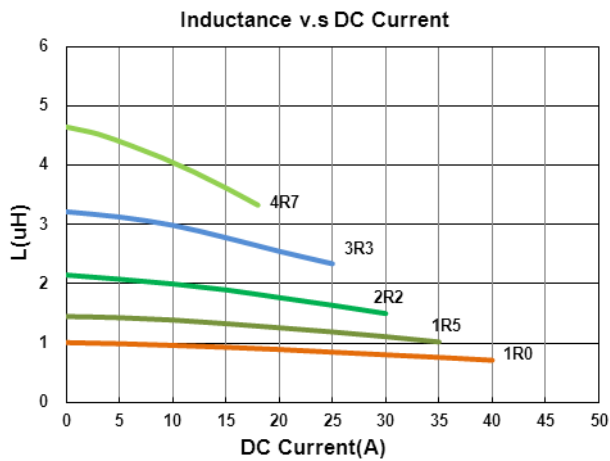

Packaging Specifications

Tape Dimensions

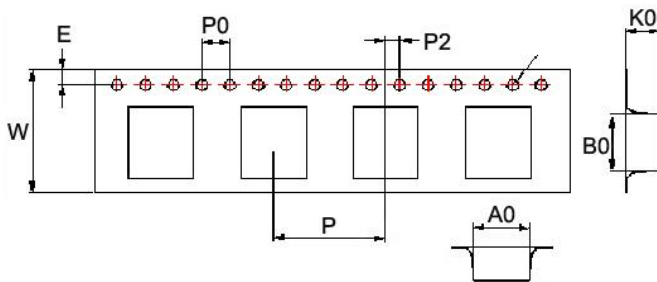

Tape Material

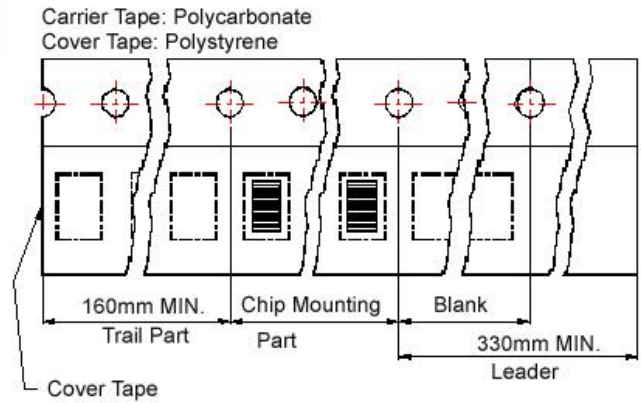

Reel Dimensions

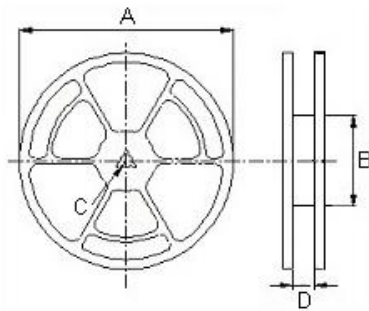

Dimensions in mm

TYPE	Tape Dimensions									Reel Dimensions				Quantity PCS / REEL
	A0	B0	K0	D	E	W	P	P0	P2	A	B	C	D	
BMCB00060615	6.9	7.6	1.9	1.55	1.75	16	12	4	2	330	100	13	16.0	1000
BMCA00060630	6.9	7.6	3.4	1.55	1.75	16	12	4	2	330	100	13	16.0	1000
BMCA00101040	10.6	11.7	4.25	1.55	1.75	24	16	4	2	330	100	13	24.4	500